



BBC

R&D White Paper

WHP 091

July 2004

Ferrite Rod Antennas for HF?

R.H.M. Poole

Research & Development
BRITISH BROADCASTING CORPORATION

Ferrite Rod Antennas for HF?

R.H.M. Poole

Abstract

At present, portable receivers generally use ferrite rod antennas for LF and MF (below 2 MHz), and whip antennas for HF (up to 30 MHz). Each type has proved effective in its particular application. However, a whip antenna is much less convenient for the user of the receiver, and the obvious question is whether a ferrite rod could be used instead at HF. Yet another possibility is the loop or frame antenna, which was popular before the introduction of ferrite rods. With the BBC wishing to expand transmissions of DRM, the subject is becoming increasingly important.

This report discusses the use of loop and ferrite rod antennas at HF, and presents both theoretical and practical results. It also introduces a spreadsheet calculator for allowing the user to assess the effects of altering the various parameters. The conclusion is that ferrite rods are suitable for use at HF, but that frame antennas could be even better.

The report was prepared for the information of staff involved with radio reception in general and the DRM project in particular.

Additional key words: Electric field, magnetic field, field strength, relative permeability, complex permeability.

White Papers are distributed freely on request.
Authorisation of the Chief Scientist is required for
publication.

© BBC 2004. All rights reserved. Except as provided below, no part of this document may be reproduced in any material form (including photocopying or storing it in any medium by electronic means) without the prior written permission of BBC Research & Development except in accordance with the provisions of the (UK) Copyright, Designs and Patents Act 1988.

The BBC grants permission to individuals and organisations to make copies of the entire document (including this copyright notice) for their own internal use. No copies of this document may be published, distributed or made available to third parties whether by paper, electronic or other means without the BBC's prior written permission. Where necessary, third parties should be directed to the relevant page on BBC's website at <http://www.bbc.co.uk/rd/pubs/whp> for a copy of this document.

1. Introduction

At present, portable receivers generally use ferrite rod antennas for LF and MF (below 2 MHz), and whip antennas for HF (up to 30 MHz). Each type has proved effective in its particular application. However, a whip antenna is less convenient for the user of the receiver — it is likely to break off! — and the obvious question is whether a ferrite rod could be used instead at HF. Yet another possibility worth considering is the loop or frame antenna, which was popular before the general introduction of ferrite rods in about 1960. With the BBC wishing to expand transmissions of DRM, the subject is becoming increasingly important.

This report starts by looking at the basic theory behind the three types of antenna, and compares their expected relative performance. The theory is easy to apply for simple loops and whips, but unfortunately the presence of ferrite complicates matters greatly — so much so that an analytical treatment appears not to be possible.¹ Instead, for help, we must turn to a mixture of manufacturers' data, experimental results and computer simulation. This work, to 'understand' ferrite rod antennas, occupies the bulk of the report. No claims to great scientific originality or accuracy are made. The report ends with a comparison of ferrite rod and frame antennas.

A useful by-product of the work is a spreadsheet for enabling the reader to assess the performance of an antenna for himself. Details are given in the appendix, but the results appear in main body of the report where appropriate.

2. Electric Field Antennas

Electric field antennas, of which the whip is an example, make use of *capacitors*. Suppose the local electric field strength is given by $E = E_0 \cos \omega t$ volts/metre, and that we attempt to use a capacitor to extract energy from that field, as below:

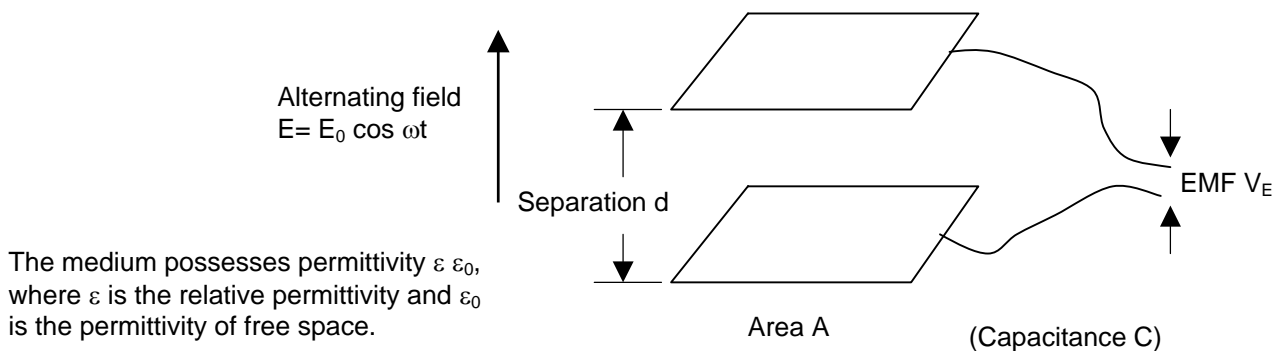

Figure 2.1: An Electric Field Antenna

Suppose that we apply a voltage V_E across the capacitor plates, such that $V_E = d \times E_0 \cos \omega t$. Since the resulting field between the plates is then $E_0 \cos \omega t$, which exactly matches the field that already exists, no current flows into the capacitor. Hence the EMF generated by the antenna equals V_E , or $d \times E_0 \cos \omega t$.

Now suppose that we remove the external field E , but maintain V_E across the capacitor plates. V_E now gives rise to a current flow which we calculate as follows. A capacitor is defined by the ratio of stored charge q to the applied voltage; that is, $C = q/V$. Alternatively, $C = (dq/dt) / (dV/dt) = I / (d \times -\omega E_0 \sin \omega t)$, where I is the current. This gives the well-known result that the impedance Z_E , which equals V/I , is $1 / (j\omega C)$.

¹ The author is willing to be proved wrong!

The above arguments show that an alternating field E gives rise to an EMF $E \times d$, which is available through a source impedance $1 / (j\omega C)$. Since C is given by $\epsilon\epsilon_0 A/d$, the modulus of the impedance becomes $d / (\omega \epsilon\epsilon_0 A)$. For likely dimensions and wavelengths, this is quite high. Suppose $d = 1$ m, $\omega = 10^7$ (top end of the medium waveband) and $A = 10^{-4}$ m². Since $\epsilon = 1$ (in free air) and $\epsilon_0 = 8.84 \times 10^{-12}$, $|Z|$ is just over 1 M Ω .

For the frequencies of interest in this report, a parallel-plate capacitor is hardly practicable — particularly with dielectric material between its plates. However, its near-relation the whip antenna is commonly used at HF. It comprises a ground-plane — in a portable receiver, generally the printed circuit board — and an extendable metal rod of length l . The capacitance is more difficult to calculate, since this is now distributed and not confined to a pair of plates; and the EMF is approximately $E \times l/2$, since the antenna responds to the average potential of E along the length of the whip.

By making the antenna the capacitive element of a parallel tuned circuit, it is possible to realise the full value of the EMF. This is rarely done, because changes in the environment — such as the presence of the user — change C and cause serious detuning. Instead, the antenna may be used to current-drive a low impedance point. The modulus of the available current is $V / |Z|$ or, for the parallel-plate antenna, $(E \times d) / (d / (\omega \epsilon\epsilon_0 A))$, which equals $\omega \epsilon\epsilon_0 A E$. Note that, perhaps surprisingly, this is independent of d but proportional to ω .

Little more need be said about E-field antennas here. It is not possible to progress further without details of the antenna's environment and knowledge of the associated electronic circuitry. The theory is adequate for us to gain some idea of the relative merits of E- and H-field antennas.

3. Magnetic Field Antennas

Magnetic field antennas, of which frame and ferrite rod antennas are examples, make use of *inductors*. Suppose that the local magnetic field strength H equals $H_0 \cos \omega t$ amperes per metre, and that we attempt to use a circular loop of wire to extract energy from that field, as below:

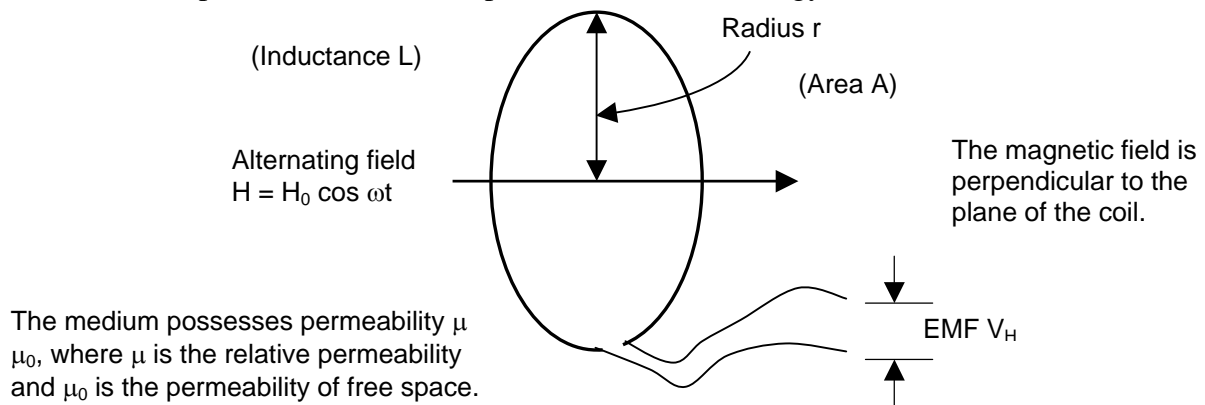

Figure 3.1: A Magnetic Field Antenna

In this case, $V_H = \mu \mu_0 A (dH/dt)$. Since H equals $H_0 \cos \omega t$, the magnitude of the output $|V_H|$ becomes $\mu \mu_0 A \omega H_0$. Strictly, H_0 represents the amplitude of the field, but it can be taken as the RMS value, provided that V_0 is expressed in the same way. For a circular loop, it is often more convenient to substitute πr^2 for A .

The source impedance Z_H is determined by the self-inductance of the loop, L , and is $j\omega L$. Unfortunately, calculation of L is very difficult, and it is necessary to resort to empirical formulae or computer simulations. More will be said about self-inductance in the following sections.

To get some idea of the relative signal levels from electric and magnetic field antennas, suppose that E is 1 volt/metre. In that case, the electric field antenna can deliver 1 V into high impedance, if d is 1 m. If E is associated with a wave being propagated in free space, H equals E / Z_0 , where Z_0 ($\approx 120 \pi$) is the impedance of free space. Substituting into $|V_H| = \mu \mu_0 A \omega H_0$ gives

$$|V_H| = 1 \times (4 \pi \times 10^{-7}) \times 1 \times 10^7 \times (1/120 \pi),$$

where the area has been taken as 1 square metre, and ω as 10^7 as before. This equals 1/30.

Despite the inconveniently large area of the loop, $|V_H|$ is much less than $|V_E|$ from the E-field antenna. However, all is not lost, for the following reasons:

- The output of the loop can be increased considerably by tuning the loop with a capacitor:

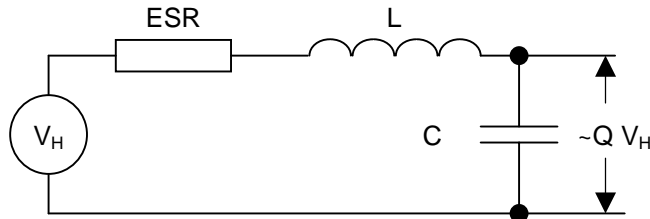

Resonant angular frequency ω_0 is given by $\omega_0^2 = 1/LC$.

Quality factor Q is given by $\omega_0 L /$

A Q of 100 is usually easy to achieve, and $|V_H|$ will be multiplied by this amount.²

- It is possible to use more than one turn: N turns will multiply $|V_H|$ by N .
- Introducing a ferrite material increases μ , although, as will be seen, μ cannot normally be equated to the relative permeability of material: geometry is also important.³
- The output for a given field strength is proportional to frequency.
- The performance of E-field antennas appears good, but in practice the full output is unlikely to be realisable because of the very high source impedance.

Before progressing further, we should briefly consider the various components of the equivalent series resistance, or ESR. A much more complete treatment of the subject is presented in [1], and the following formulae are quoted from that source.

In an ideal world, the only contribution to the ESR would be the radiation resistance of the coil. Optimum system noise performance is obtained by matching the ESR to the input impedance of the following amplifier. However, [1] states that the radiation resistance for a single turn is given by

$$R_r = 197 C_\lambda^4 \Omega,$$

where C_λ is the ratio of the circumference to the wavelength. This is negligible for any normal dimensions and will be swamped by the loss resistance R_L resulting from the skin effect:

$$R_L = R_r 3430 / \{C^3 f_{\text{MHz}}^{3.5} d\} \Omega \text{ per turn,}$$

where C is the circumference in metres and d is the diameter of the wire in metres. As explained in the next section, a consequence of this statement is that the noise performance can never be good. Loop antennas are only acceptable at MF because atmospheric noise is so great.

Finally, if a ferrite material is present, the Q cannot exceed the ratio of the real (μ_r') to imaginary components (μ_r'') of the complex permeability. The equivalent resistance R_f is given by

$$R_f = \omega_0 L (\mu_r'' / \mu_r').$$

² This statement is a slight approximation.

³ It might seem that an H-field antenna could be made arbitrarily good by increasing the number of turns and the permeability of the material. However, doing this also increases the self-inductance, and hence reduces the resonant frequency for a given value of tuning capacitor.

4. Why Aim for a High ‘Q’?

One of the comments made about the draft version of this report may be paraphrased as follows: ‘You have taken it for granted that a high Q is a “good thing”; surely it is more important to aim for the best possible noise performance?’ The implied question is worth answering.

The first reason for adopting a high Q is that traditional receivers rely heavily on the selectivity of the antenna. A typical arrangement is to convert the signal down, in a single stage, to an intermediate frequency (IF) of about 465 kHz. If the incoming signal is at 20 MHz, and the Q is an optimistic 200, the 3 dB bandwidth of the antenna is 100 kHz. The image response is separated from the wanted signal by twice the IF — say 1 MHz — and is attenuated by only 26 dB. A lower Q results in an even worse performance. Of course, with the advent of DRM, there is an opportunity for better receiver design. Even so, selectivity might still be desirable to avoid problems being caused by strong out-of-band signals.

The second reason is that a high Q usually does give the best noise performance. Firstly, consider an ideal antenna where losses such as the skin effect are negligible. This will possess a radiation resistance R_r , and we may suppose that the following circuitry presents a load R_l . For the moment, we are not concerned with the following amplifier stage.

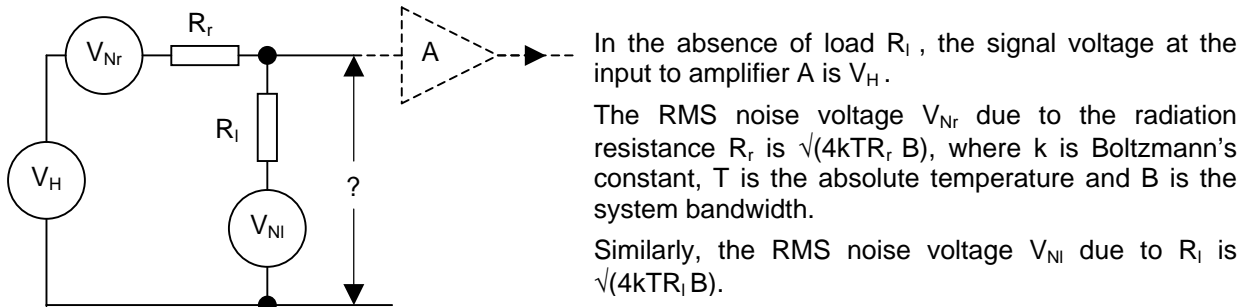

Figure 4.1: Equivalent Circuit of an Ideal Antenna and Load

The ratio of noise voltage to signal voltage at the input to the amplifier is straightforward to calculate. The signal voltage S and each of the two noise voltage contributions are divided by the action of R_r and R_l . Because the noise contributions are uncorrelated, their mean square voltages must be added to give the overall mean square noise voltage N^2 :

$$S = V_H R_l / (R_r + R_l) \quad \text{and} \quad N^2 = \{V_{Nr} R_l / (R_r + R_l)\}^2 + \{V_{Nl} R_r / (R_r + R_l)\}^2;$$

and so $(N/S)^2 = \{(4kTBR_r R_l^2) + (4kTBR_l R_r^2) / (V_H R_l)^2\} = (4kTBR_r / V_H^2) (1 + R_r / R_l)$.

A plot of $(N/S)^2$ as a function of R_l/R_r appears as below:

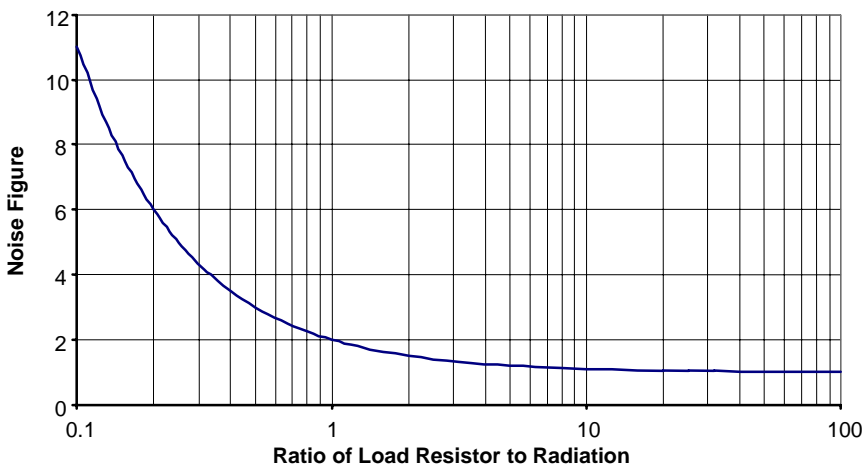

This plot of $(N/S)^2$ can be taken as the noise figure F of the circuit, since the constant factor $4kTBR_r / V_H^2$ equals the ratio of available noise power to available signal power, and represents the best performance theoretically achievable.

F approaches 1 for large R_l .

Figure 4.2: Noise Figure Plotted as a Function of Load Resistance

‘Matching’ the antenna by making R_l equal R_r results in a noise figure of 2, and clearly does not result in the best possible performance. Of course, R_l is not necessarily an actual resistor placed across the antenna output; it could be the dynamic impedance of a tuned circuit.

Where the following amplifier introduces noise, it becomes doubly important to maximise S by making R_l as large as possible. A typical amplifier for use up to 30 MHz can be modelled as an ideal device with a noise voltage in series with its input. If this is true, it is obvious that the effect of the noise is minimised by maximising the signal input.⁴ The situation is helped by designing the antenna circuit to possess a high Q : a Q of 100, for instance, results in the signal voltage being magnified 100 times. Since the noise voltage associated with R_r increases by the same factor, the noise figure at the input to the amplifier does not change as a result.

Real electrically-small antennas are very inefficient. Suppose we take the frame antenna below:

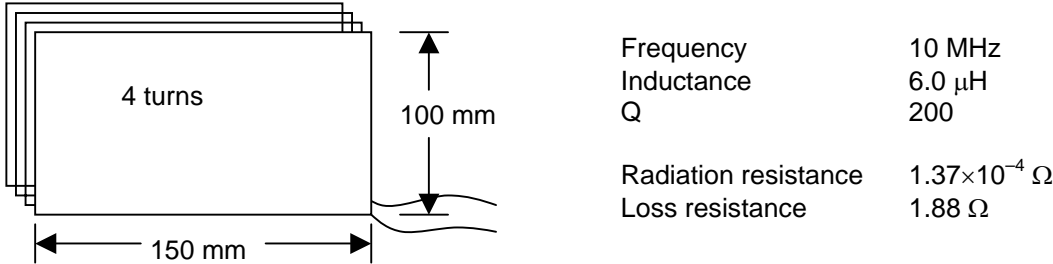

Figure 4.3: An Example of a Frame Antenna

The radiation resistance R_r was calculated from the formula given in the previous section, whilst the loss resistance is simply the inductive reactance divided by Q . If the figure for R_r is correct, the noise power associated with the loss resistance exceeds that due to the radiation resistance by a factor of 14,000, or 41 dB. That seems like a disaster until external noise is taken into account:

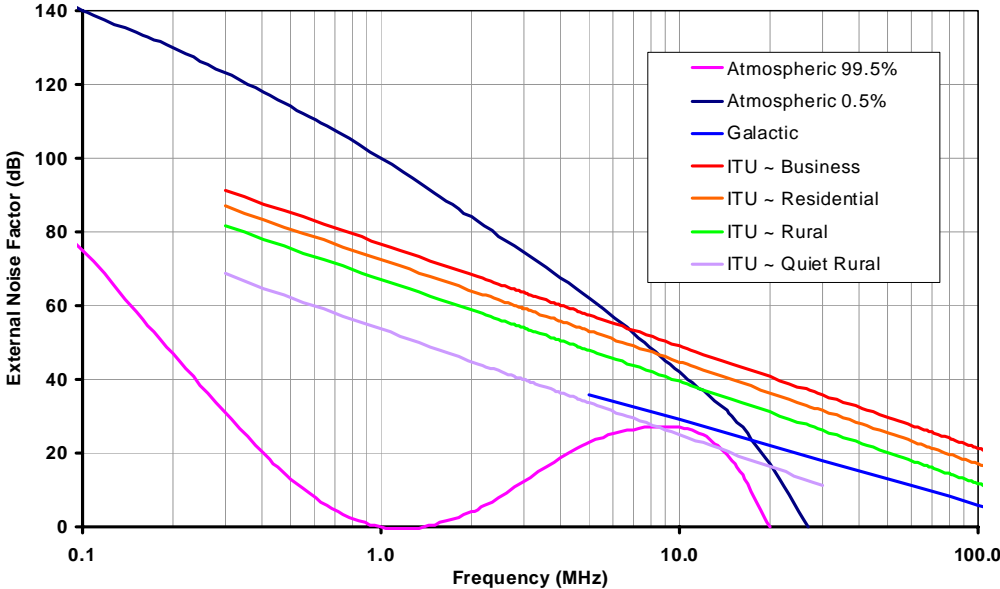

Figure 4.4: Excess Atmospheric and Man-Made Noise [9]

Atmospheric and man-made noise is at least comparable to the noise introduced by losses within the antenna. The antenna is good enough! Note that, where the losses in the antenna are substantial, a larger Q implies lower losses and hence lower noise. This was not true for the ideal antenna originally considered.

⁴ We are assuming that the input impedance of the amplifier is very high. If so, there can be no input noise current.

5. Ferrite Rod Antennas

The ferrite rod antenna is a special case of the general magnetic field antennas just discussed. As mentioned in the introduction, ferrite rod antennas have been the usual method of receiving LF and MF transmissions for some 40 years — at least in portable sets. Typically, the rod itself is about 140 mm long and 10 mm in diameter, and is made of a substance possessing very high relative permeability. A standard value for use at LF and MF is 800, but the range covers 20 to 10,000 at least. [2] and [3] Generally, the higher the permeability, the lower the useful maximum frequency: above that frequency, the material rapidly becomes lossy.⁵ The characteristics shown below are for Neosid material F14: [4]

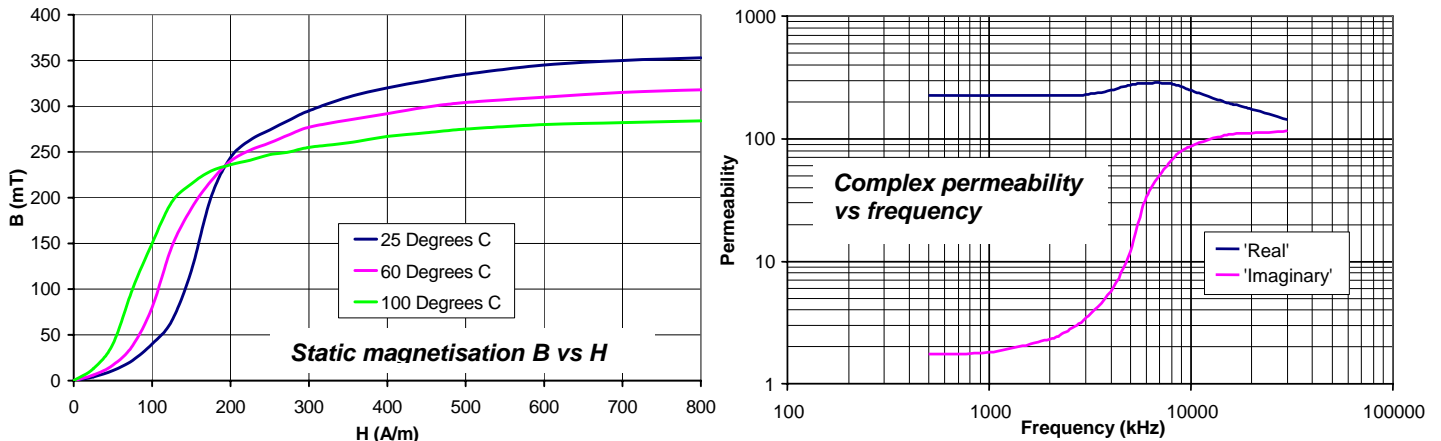

Figure 5.1: Manufacturer's Data for Neosid F14 Material

More will be said about the material characteristics, but note both the large temperature dependence and the increase of 'imaginary' permeability, or loss, with frequency.

A coil of fine wire, forming a solenoid of typical length 25 mm, is wound around the rod. Since the coil forms part of a tuned circuit, some adjustment of the self-inductance is desirable; hence the coil is often wound on a former which can slide along the rod. The self-inductance is greatest when the coil is at the centre of the rod. When the correct position has been found, the former is locked in place with beeswax.⁶ There is often a smaller, closely coupled, coil whose purpose is to feed the signal to a low-impedance device without seriously damping the tuned circuit.

The effect of the rod is complicated. As hinted above, the presence of the rod increases the self-inductance of the coil. Also, of course, it increases the sensitivity of the antenna to external magnetic fields, but not usually by the same amount. It is useful to define the following terms:

Term	Definition	Comments
l/d	Ratio of rod length to diameter.	The 'geometry' of the rod.
μ_r	Relative permeability of rod material.	Can be divided into 'real' and 'imaginary' components μ_r' and μ_r'' respectively.
μ_{rod}	Relative 'rod' permeability: the effective magnification of an external magnetic field $\mu_0 H$.	Equivalent to the magnification of the induced signal voltage V_H .
μ_{coil}	Relative 'coil' permeability: the effective magnification of a self-generated magnetic field.	Equivalent to the magnification of the self-inductance L .

Table 5.1: Definitions of the Various Terms Used in This Report

⁵ This property may be helpful. Ferrite beads are often used to remove high-frequency interference, and to prevent parasitic oscillations. At low frequencies, the bead adds a small amount of series inductance; at higher frequencies it appears as resistance of perhaps a few hundred ohms.

⁶ An alternative is to fix the coil and adjust the inductance by means of a sliding collar which contains a shorted turn. Moving the collar towards the coil reduces the self-inductance.

The increase in sensitivity to external fields is characterised by μ_{rod} . If the rod is very long in comparison to its diameter ($l/d \rightarrow \infty$), μ_{rod} equals the relative permeability of the material, μ_r . However, for typical lengths ($l/d \approx 15$), μ_{rod} is mainly determined by l/d , and is almost independent of μ_r , as the manufacturer's information below shows: [3]

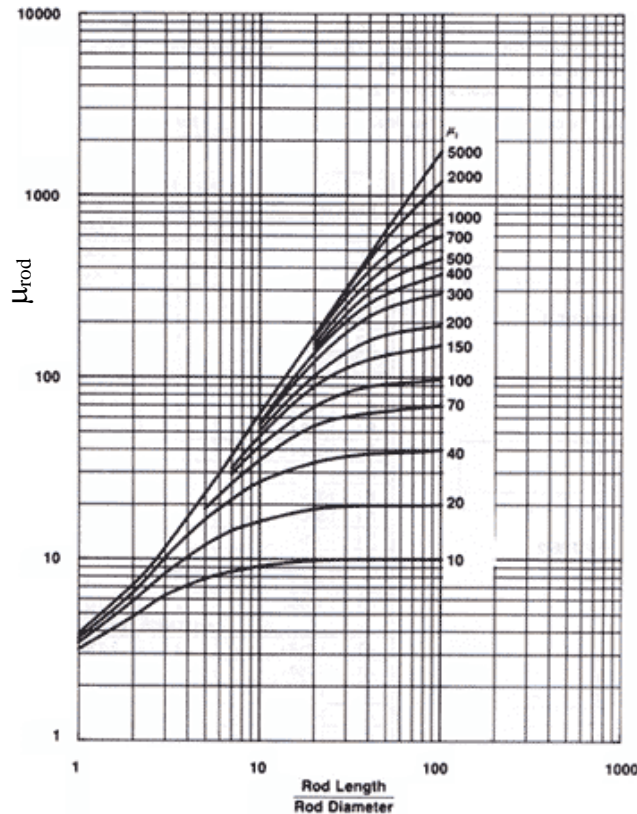

For small l/d , the effective permeability approximates to
 $\mu_{rod} = (l/d)^{5/3} + 2.5$, for $\mu_{rod} \ll \mu_r$.

For large l/d , $\mu_{rod} \approx \mu_r$.

The following modified value of μ_{rod} — μ_{rod}' — is a good approximation for all values of l/d :

$$\mu_{rod}' = (\mu_{rod} \times \mu_r) / (\mu_{rod} + \mu_r).$$

Figure 5.2: Effective Permeability for Different Material Permeabilities and l/d Ratios

For $l/d = 15$ and $\mu_r = 250$, the relative rod permeability is about 80. If μ_r were infinite, the value would only be slightly greater than 100. According to Figure 5.1, μ_r varies by a factor of 2:1 over 75°C. Such a temperature coefficient makes it fortunate that, for practical values of l/d , μ_r has only a remote effect on μ_{rod} .

The self-inductance of the coil is important because it determines the resonant frequency of the antenna tuned circuit. Once again, the relative coil permeability, μ_{coil} , approaches μ_r for very long rods. However, for typical values of l/d , μ_{coil} is much less than μ_{rod} . The reason is that the presence of the rod concentrates the magnetic field, but then introduces a large effective air-gap. It is easy to visualise the rod being bent round to form a toroid, in which case $\mu_{coil} \approx \mu_r$, and then being straightened out, the air-gap increasing in the process.

Analytical calculations of μ_{coil} and hence inductance are very difficult, except in the simplest of circumstances. One possibility is to carry out a computer simulation using the 'method of moments'⁷, as one brave researcher has done. [5] However, if this is done, it is very wise to check the results against practical measurements. Sometimes, manufacturers provide so-called A_L values for their ferrite rods — presumably also obtained by measurement. An A_L value is (normally) defined as the coil inductance in mH for 1000 turns. The actual inductance is calculated on the assumption that inductance is proportional to the square of the number of turns.⁸

⁷ This involves dividing the ferrite rod (for instance) into a large number of pieces, each of which can be treated in a simple way. The pieces are then joined together in a way that respects their boundary conditions.

⁸ This assumption is close to the truth when the ferrite rod is present, but certainly not so for long coils or solenoids in the absence of a rod. The difference in behaviour between the two situations is one reason for the complicated dependence of μ_{coil} on the various rod and coil parameters.

Unfortunately, the quoted A_L values are not necessarily helpful. Those listed in [3] assume that the coil is ‘closely wound in 22 gauge wire, placed in the centre of the rod, and covering nearly the entire length’. Obviously, the last of these of these conditions cannot apply to an HF coil containing only a few turns. The reference provides a corrected μ for shorter coils:

$$\mu_{\text{corr}} \approx \mu_e \sqrt[3]{(l_r / l_c)},$$

where (l_r / l_c) is the ratio of rod to coil lengths. However, the formula cannot work for very short coils; what is more, it is not clear whether μ_e refers to μ_{rod} or μ_{coil} .

The appendix of this report provides an inductance calculator, derived as follows. The inductance of the coil alone is calculated from one of Wheeler’s empirical formulae. Although ‘Wheeler’ has little theoretical justification, it is ‘tried and tested’ and can be used with confidence. Following that, the inductance is multiplied by μ_{coil} from the computer simulation [5]. Since the simulation is not ‘tried and tested’, the predictions are checked, where possible, against experimental data.

Experimental results will be presented later. However, a typical value of μ_{coil} for a short coil is 8 — only a tenth of the value of μ_{rod} . We can now estimate how much good a ferrite rod does. If we assume that the inductance of the coil needs to be the same after inserting the rod, the number of turns must be reduced by a factor of $\sqrt[3]{8}$. This, of course, reduces the induced signal voltage by the same factor. On the other hand, the induced signal voltage is increased by 80 times, thanks to μ_{rod} . Overall, the signal level is increased by $80 / \sqrt[3]{8}$ times, or a factor of about 28.⁹

6. Experimental Arrangements

In order to check the information gained so far, some lab measurements were made. Two different ferrite rods were available: firstly, a typical MF antenna rod, 140 mm long and 9.3 mm in diameter, made of F14 material; secondly, a very large HF rod, 200 mm long and 30 mm in diameter.¹⁰ The material of the second rod was not known for certain, but μ_r was probably 125, as this is a standard value. A few turns of wire were wrapped around the rod, so that self-inductance of the resulting coil was about 4 μH — a suitable value for use at HF. A component bridge was available for measuring inductance accurately at any frequency below 13 MHz. It could also measure the equivalent series resistance (ESR), but not so reliably since the much greater inductive reactance tended to swamp the result.

For measuring the performance of the antennas, a signal generator and Meguro test loop were used as follows:

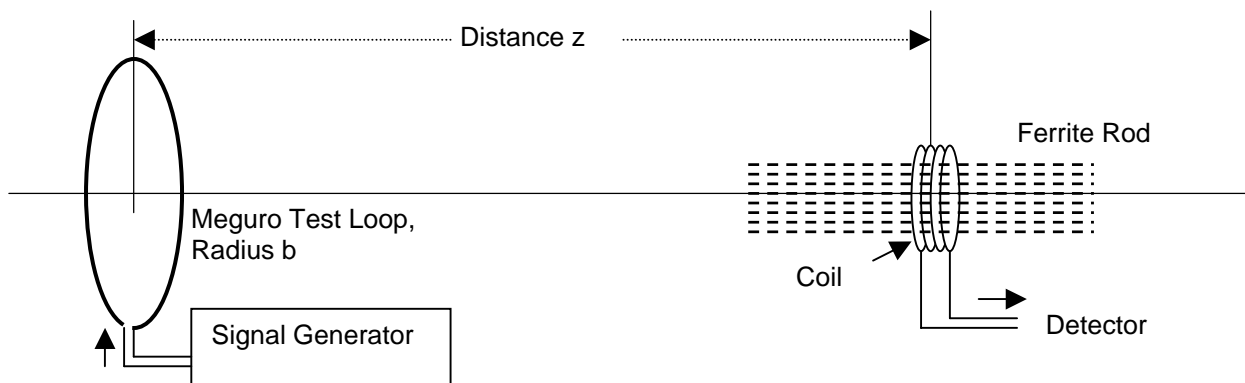

Figure 6.1: Use of the Meguro Test Loop for Assessing Antenna Performance

⁹ With the more usual MF antennas, where the coil is longer, the increase in signal level would not be as great.

¹⁰ The rod was taken from a direction-finding apparatus for use at frequencies up to 30 MHz.

If a current I flows through the test loop, the field generated is given by

$$H_z = (I b^2 / 2) / (b^2 + z^2)^{3/2} \equiv E / 120 \pi,$$

where the radius b is 0.125 m and distance z is traditionally 0.6 m. The loop includes a series resistor of 86Ω . This, together with a generator source impedance of 50Ω , gives rise to a magnetic field whose equivalent electric field E is 10 mV/m when the generator EMF is 100 mV. During the tests, z was made somewhat greater, to reduce variation of the field over the length of the rod.¹¹ The spreadsheet of Appendix 1 makes it easy to calculate H_z , and to predict the induced EMF in a coil.

The predicted EMF is given by

$$E_{HU} = N (\mu_{rod} \mu_0) H_z (\pi r^2) (2\pi f),$$

where N is the number of turns, $(\mu_{rod} \mu_0)$ is the permeability of the medium, (πr^2) is the area of the coil, and $(2\pi f)$ is the angular frequency. Of course, μ_{rod} is unity where the ferrite rod is absent. E_{HU} was measured by connecting the coil directly to the input of a spectrum analyser, since typical values were too small to be seen on a scope. The source impedance of the coil, $j(2\pi f)L$, was then comparable to the 50Ω load impedance, and had to be taken into account. Again, the spreadsheet performs the necessary calculations.

A final practical point is the choice of frequency. It might seem desirable to measure HF antennas at the top end of their working range. However, at such frequencies, the Meguro test loop generates appreciable E fields, despite being screened. Spurious pick-up then spoils the results. A second reason for using lower frequencies is that the source impedance of the coil is lower and has less effect on the measured value of E_{HU} . Unless otherwise stated, the test frequency was 2 MHz.

7. Performance of the ‘Small’ Rod

The more comprehensive set of measurements was made on the ‘F14’ MF rod: it was impracticable, for instance, to break up the large HF rod into smaller pieces to explore the effect of varying l/d . Spreadsheet ‘A’, as described in the Appendix, was used to predict both the self-inductance L and the induced signal level E_{HU} ; the hope was that these would agree with the experimental values. Where relevant, values of μ_{coil} and μ_{rod} are quoted from Spreadsheet ‘B’, the computer simulation of [5]. It is only possible to check these values by inference, as the spreadsheet does not present actual values of L and E_{HU} .

The relevant parameters entered into the spreadsheet are given below. Details of the generating loop are shown in Appendix 1.

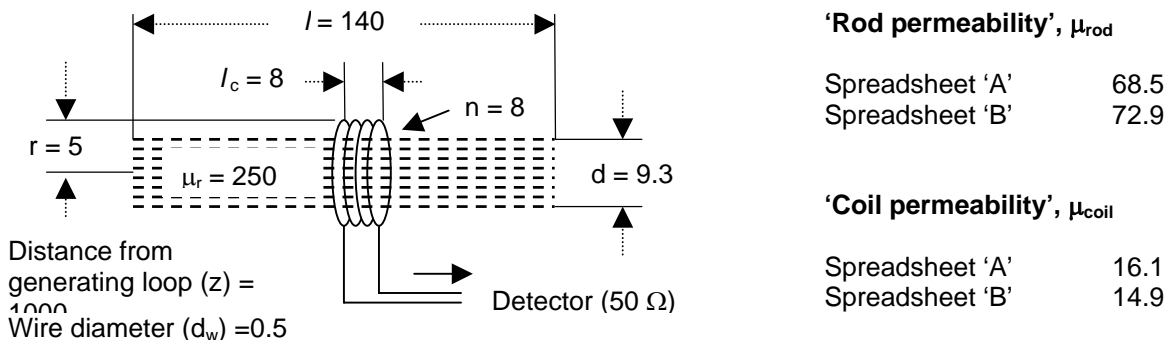

Figure 7.1: Parameters Associated with the ‘Small’ Rod

¹¹ The distance of 0.6 metres is specified in British Standard 4054 [8]. However, the Meguro loop itself does not conform to this standard. Note also that the manufacturers of the loop quote a simplified formula for H_z , which ignores the presence of b^2 in the denominator. The resulting error is about 6%.

The two spreadsheets agree well on the rod permeability — which is comforting, as ‘A’ bases its calculations on manufacturer’s data, whereas ‘B’ performs a simulation.¹² There is also good agreement on coil permeability, but this is not surprising as ‘A’ was intentionally designed to match ‘B’. Whether ‘B’ is correct can only be confirmed by experiment.

Perhaps now is the time to own up to a small amount of ‘cheating’. ‘B’ makes an allowance for the coil and rod diameters being slightly different. It does this by giving a modified value of μ_{coil} , but leaves μ_{rod} unchanged. Instead, it gives a ‘pick-up correction factor’ which decreases as the ratio of coil diameter to rod diameter increases. The easier approach, adopted by ‘A’, is to take the coil diameter as being equal to the rod diameter. Provided that the rod is actually present, the errors introduced are very small, but the true coil diameter should always be entered if the rod is absent.¹³

Position of Coil on Rod

Figure 7.2 below shows the relationship between output voltage and position of the coil on the rod. ‘0.5’ corresponds to the coil being placed centrally, whilst 0.0 and 1.0 correspond to it being at either end. The dark blue curve was calculated using Spreadsheet ‘B’, and amounts to the ‘correction factor’ given for ‘coil position and size’; the actual measurements are given by the pink curve.

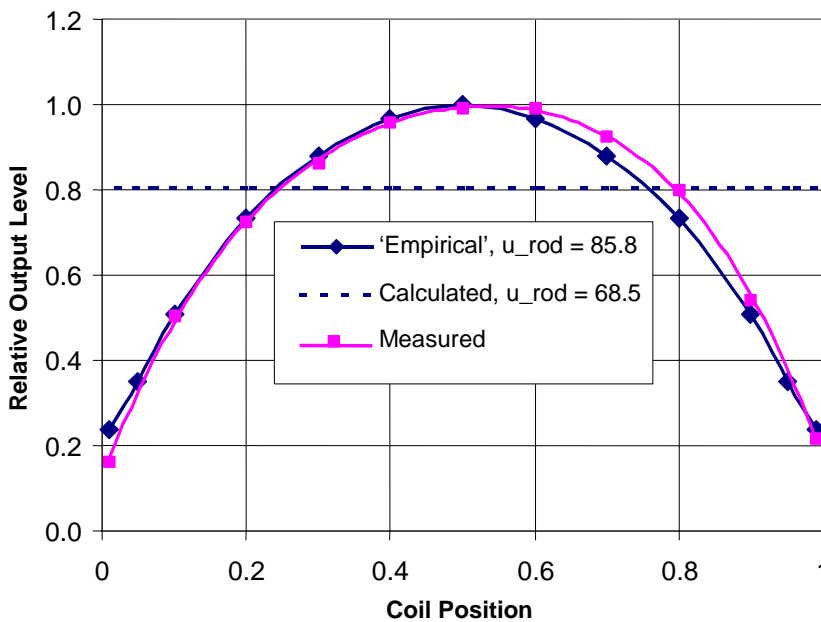

If μ_{rod} is taken as 85.8 — the ‘empirical’ value quoted by ‘B’ — the calculated and measured levels agree closely. (A relative value of 1 corresponds to an absolute value of -71.7 dBm into an open circuit.) However, the ‘calculated’ values of μ_{rod} from ‘A’ and ‘B’ result in a level about 1.9 dB lower.

Note that the measured results are slightly skewed towards coil position 1. This is probably because the coil was being moved closer to the generating loop.

Figure 7.2: Variation in Output as a Function of Coil Position

¹² In fact, Spreadsheet ‘B’ also provides an empirically derived value, in this case 85.8.

¹³ Ignoring the difference between coil and rod diameters seems a reasonable thing to do, since the rod is responsible for most of the magnetic flux linkage. In any case, it is normal for the coil and rod diameters to be nearly the same. The ‘large’ HF rod is an exception to the rule, thanks to its unusual construction — it possesses a sleeve of approximate thickness 2.5 mm.

Spreadsheet ‘B’ gives a second correction factor, determined by the coil size and position. This factor affects the signal level, and is effectively a multiplier for (the constant) μ_{rod} . Provided that the coil is near the centre of the rod, the factor is very close to unity. μ_{coil} is calculated separately, and is not subject to a correction factor: μ_{coil} varies with coil size and position. It is not clear why μ_{coil} is taken as a variable, whereas μ_{rod} is a constant with an effect that depends on a correction factor.

Figure 7.3 below shows the exercise being repeated for the coil inductance. Measurements were more difficult to make, as the inductance depends on a greater number of factors. For instance, the coil length is now critical, whereas it made little difference to the output level. The greatest difficulty was determining the inductance with the ferrite removed. Not only was the inductance very small, but also the coil dimensions were unstable. The value of $0.50\ \mu\text{H}$ entitled ‘free air’ is taken from the empirical formula, and is at least consistent with the measured results.

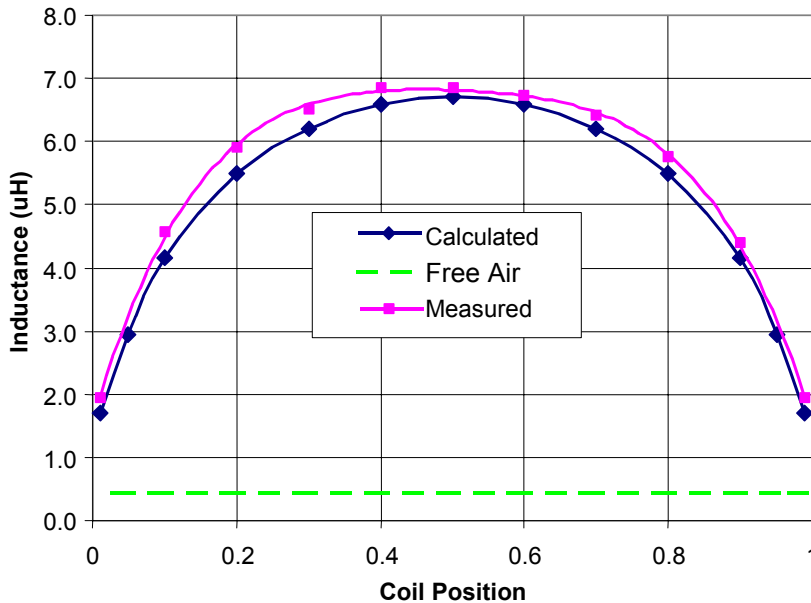

To obtain the ‘calculated’ curve, the ‘free air’ inductance of $0.50\ \mu\text{H}$ was multiplied by the μ_{coil} value given by ‘B’.¹⁴ The ‘measured’ curve represents the experimental values minus the $0.16\ \mu\text{H}$ associated with the connecting leads; that is, a measured value of $7.10\ \mu\text{H}$ is actually plotted as $6.94\ \mu\text{H}$.¹⁵

Figure 7.3: Variation of Inductance as a Function of Coil Position

Spreadsheet ‘A’ gives an inductance of $7.22\ \mu\text{H}$ for a centrally positioned coil. The good agreement with ‘B’ is only to be expected, as A’s μ_{coil} values were based on those from ‘B’ in the first place. Of course, ‘A’ is only capable of providing results for a central coil.

Ratio of Rod Length to Diameter

The next series of tests involved destroying the rod! The rod was cut in half, and one half cut in half again, and again, to give a variety of rod lengths: the various segments could be assembled in any combination and temporarily held together with tape.

Figure 7.4 below shows the relationship between the output voltage and l/d . In all cases, the coil was placed centrally on the rod. The dark blue curve was derived from the ‘calculated’ values of μ_{rod} from Spreadsheet ‘B’, whilst the actual measurements are shown by the pink curve. However, normalisation was carried out on the assumption that the ‘empirical’ value of μ_{rod} was appropriate. In other words, the signal levels predicted from the ‘calculated’ values of μ_{rod} are actually 1.9 dB lower than shown, just as was the case for Figure 7.2.

Spreadsheet ‘A’ was also capable of calculating μ_{rod} , and hence the output level, as a function of l/d . The results are not shown in Figure 7.4 because they were practically the same as those derived from ‘B’.

¹⁴ Spreadsheet ‘B’ actually offered two values of μ_{coil} — for ‘long’ and ‘short’ coils; the ‘short’ coil value was used here.

¹⁵ The inductance of the interconnections was measured by removing the rod and the squashing the coil flat!

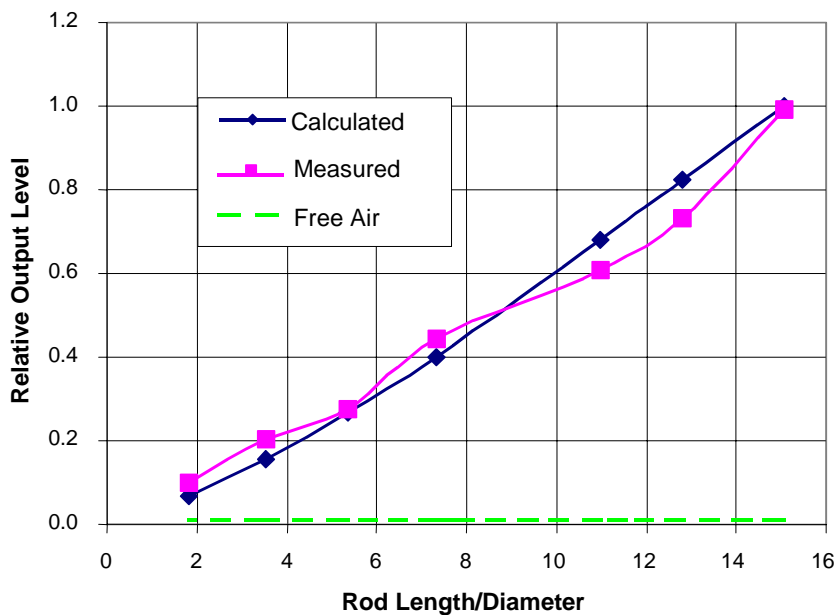

The measured output level is approximately proportional to the length of the rod, and agrees well with the predictions of the spreadsheets. Differences between the calculated and measured values are within a dB, and are easily attributable to experimental error.¹⁶ It is obvious from the plot that even a short rod has a powerful effect on the output level.

Figure 7.4: Variation in Output as a Function of Rod Length to Diameter

Figure 7.5 below shows the results for the coil inductance. As before, the ‘free air’ and ‘lead’ inductances have been taken as 0.50 μH and 0.16 μH respectively. The second set of ‘calculated’ results, in light blue, are those predicted by Spreadsheet ‘A’. An awkward question is whether to use the ‘long’ or ‘short’ coil values from ‘B’. Where l/d is large, as it normally is, the ‘short’ value is appropriate. However, for small l/d , the ‘long’ value may be better. ‘B’ does not give any clues as to where the crossover point is, and unfortunately changing from ‘short’ to ‘long’ would result in a discontinuity in the plot. Hence the coil has been assumed ‘short’ throughout. The possible error is between 5% and 10%. Agreement between the two sets of ‘calculated’ results and the ‘measured’ values is at least reasonable.

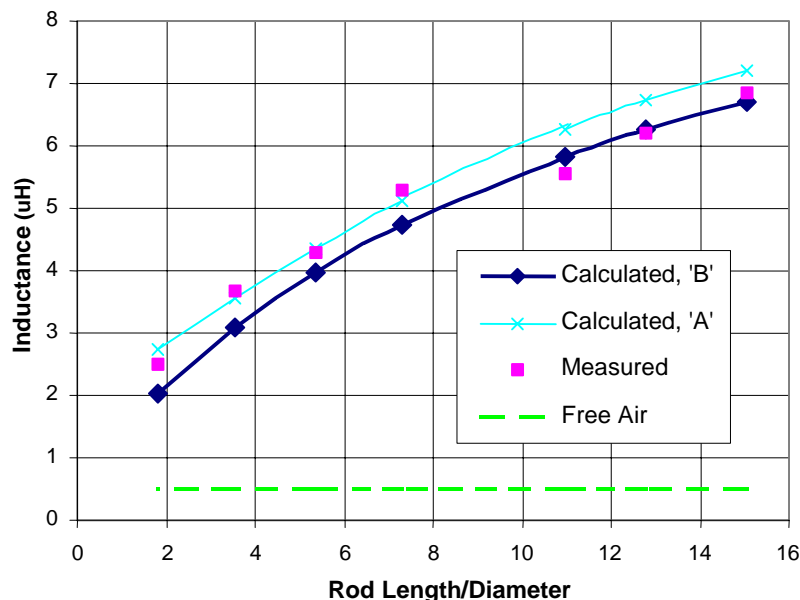

The ‘Calculated “A”’ results are taken from the spreadsheet introduced in the Appendix. Slight inconsistencies in the three sets of results arise from uncertainty in various parameters such as the free air inductance and the length of the coil.

Figure 7.5: Variation of Inductance as a Function of Rod Length to Diameter

¹⁶ For instance, between measurements the rod and coil must be taken apart, reassembled, and placed at the same distance from the loop as before. Also, the signal levels involved are quite low and difficult to measure. In particular, the ‘free air’ value at about -109 dBm was swamped by pick-up of the small electric field associated with the loop. This pick-up could be deduced by ‘squashing’ the coil, so reducing its cross-sectional area and hence the ‘legitimate’ pick-up of the H-field.

Ratio of Coil Length to Rod Length

Another subject of interest is how the effective permeability μ_{coil} depends on the coil length. Unfortunately, measurements are difficult to make, as the only practicable way of altering the coil length is to change the number of turns. Doing this obviously affects the inductance irrespective of any change in μ_{coil} . All that can be done is to use Spreadsheet 'B' to provide some calculated results, and then to perform a 'reality check' at one particular coil length.

Reference [1] gives the following formula for the coil inductance:

$$L = N^2 (\mu_{\text{rod}} \mu_0) (\pi r^2) / l_{\text{coil}},$$

where N is the number of turns, (πr^2) is the area of the coil, and l_{coil} is its length. The formula is only appropriate for 'long' coils which occupy most of the rod. Readers may recognise this as the standard formula for the inductance of an infinitely long solenoid, but with the relative permeability taken as μ_{rod} . The implication is that $\mu_{\text{coil}} \approx \mu_{\text{rod}}$. Figure 7.6 below shows the predictions of 'B' for an l/d of 15:

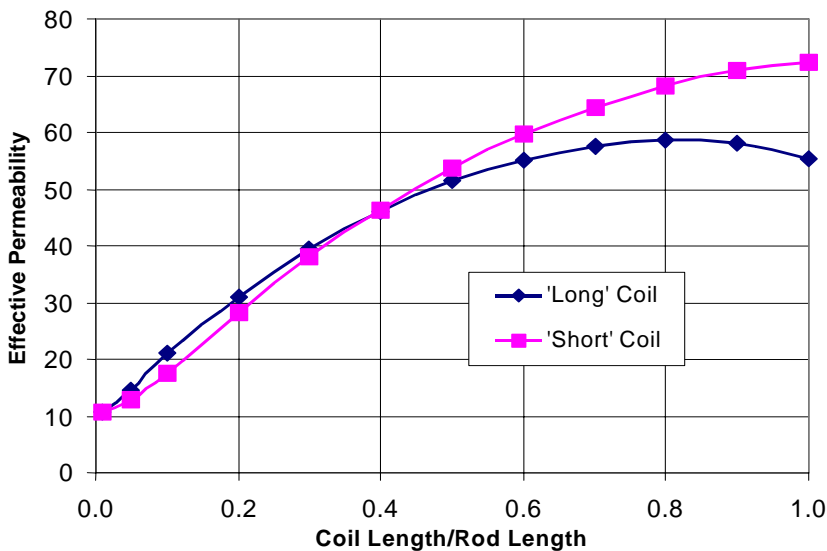

The 'long' and 'short' coil calculations agree reasonably well, provided that $l_{\text{coil}} / l_{\text{rod}}$ is below 0.4. Clearly, the coil is 'long' above this.

For a coil that occupies most of the rod, taking μ_{coil} as μ_{rod} is a reasonable approximation. For the shorter coils of interest at HF, μ_{coil} is much smaller, eventually falling to about $\mu_{\text{rod}}/8$ — a result already checked experimentally.

Figure 7.6: Variation of Permeability as a Function of Coil Length

There is also a slight change of output level: a full-length coil provides about 0.75 times the output of a short coil.¹⁷

It is clearly advantageous to keep the coil short. Because μ_{coil} is small, more turns are needed for a given inductance; hence the output level is greater. Also, the output level is the full amount appropriate to μ_{coil} , and is not reduced by end-effects (although these are relatively small).

Ratio of Coil Diameter to Rod Diameter

Finally, the effect of increasing the coil diameter alone was measured. This aspect is perhaps of limited interest, as the coil is normally wound directly on the ferrite rod — the 'large' rod discussed in the next section is an exception. The coil diameter was adjusted over the range 9.3 to 12.3 mm by adding layers of insulation tape to the rod before winding the coil. Doing this made no measurable difference to either the self-inductance or the output level. The implication is that the 'coil radius' entered in Spreadsheet 'A' should actually be the rod radius.

¹⁷ This result might appear bizarre: a shorter coil appears to provide a greater output than a long one. However, remember that the longer coil also possesses more turns.

8. Performance of the ‘Large’ Rod

The ‘large’ rod was of impressive dimensions: 200 mm long and 30 mm in diameter. It originally formed part of an HF direction-finding apparatus. Why the designers wished to use something so enormous is not clear. Although its use in a portable receiver would not be popular with either the manufacturer or the owner, its performance is still interesting. The rod material was not known for certain, but μ_r has been taken as 125, since this is a standard ‘HF’ value. Fortunately, as already discussed, the rod and coil effective permeabilities depend more on geometry than on μ_r .

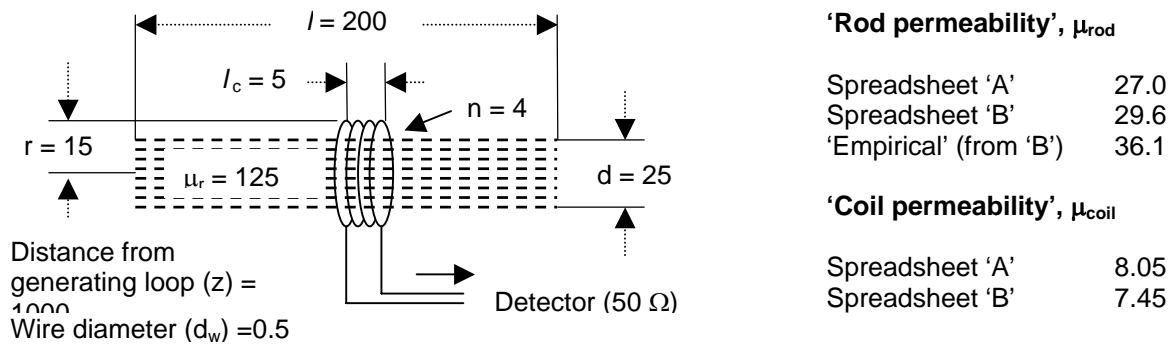
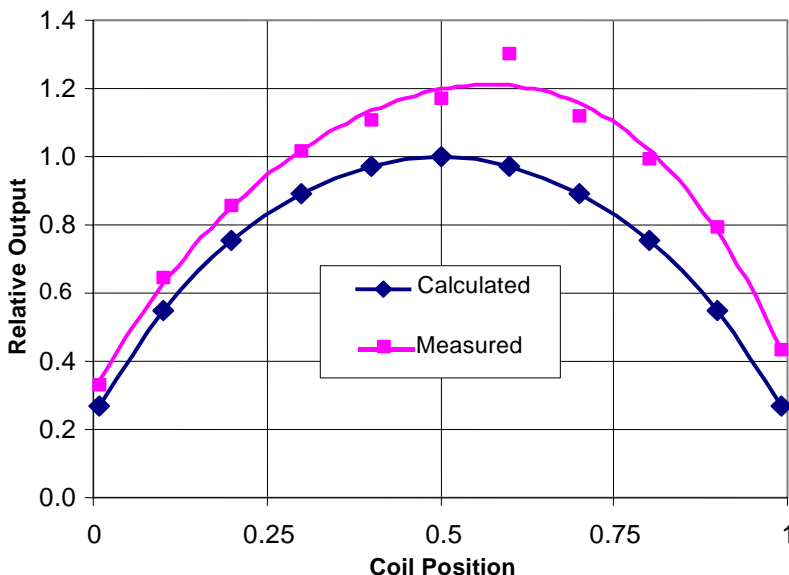

Figure 8.1: Parameters Associated with the ‘Large’ Rod

Position of Coil on Rod

Figure 8.2 below shows the relationship between output voltage and position of the coil on the rod. As before, ‘0.5’ corresponds to the coil being placed centrally, whilst 0.0 and 1.0 correspond to it being at either end. The measured values have been normalised by taking μ_{rod} as the ‘empirical’ value of 36.1, for which the predicted absolute output level is -68.0 dBm.



Agreement between the calculated and measured levels is not as good as it was for the ‘small’ rod — the measured level is about 2 dB greater than predicted. In part, at least, the discrepancy can be explained by the magnetic field not being constant over the length of the rod. If the distance from the generating loop is taken as 900 mm, corresponding to the closer end of the rod, the field strength is about 3 dB greater.

Figure 8.2: Variation in Output as a Function of Coil Position

The advantage of 3.7 dB over the ‘small’ rod seems disappointing. However, as shown overleaf, the inductance is less than before. Increasing it to the same value by adding the appropriate number of turns would give an overall advantage of about 6 dB.

Figure 8.3 below shows the results for the coil inductance. Once again, the ‘free air’ inductance of $0.79 \mu\text{H}$ is taken from the empirical formula, and the lead inductance is assumed to be $0.16 \mu\text{H}$.

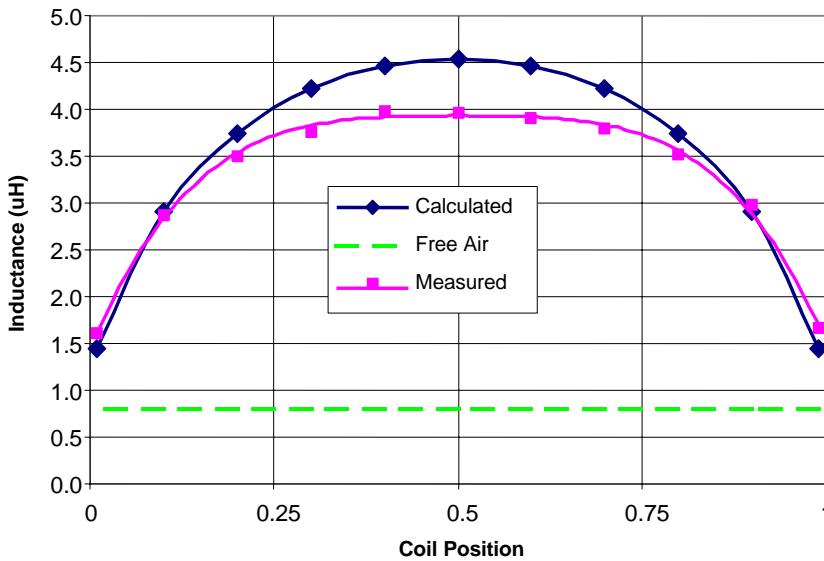

To obtain the ‘calculated’ curve, the ‘free air’ inductance was multiplied by the ‘short coil’ μ_{coil} value given by ‘B’. The agreement with the measured results is not perfect: the ‘measured’ curve is flatter than predicted. Without knowing more about the construction of the rod and the assumptions made by the model, it is not possible to say why. However, the model is still good enough to be useful.

Figure 8.3: Variation of Inductance as a Function of Coil Position

9. Inductor Quality Factor

The work so far has shown how the performance of an untuned ferrite rod antenna may be predicted with a reasonable degree of accuracy. No mention has been made of losses within the system, since they are too small to be of any significance. For instance, if the losses — ESR in the diagram below — were taken to be 1Ω , the output measured into a 50Ω load would be reduced by less than 0.2 dB .¹⁸

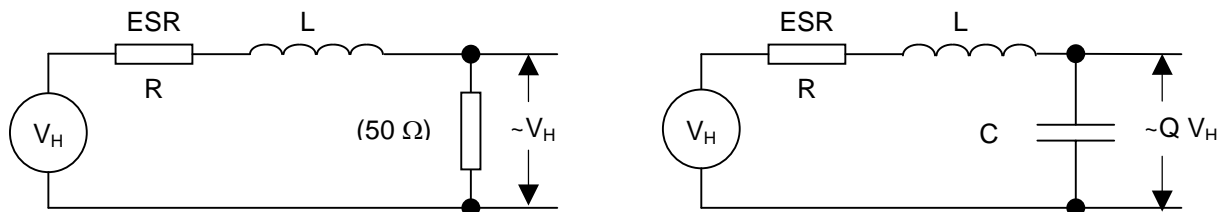

Figure 9.1: Untuned and Tuned Ferrite Rod Antennas

More usually, the antenna is tuned by adding a resonating capacitor. In that case, the ESR is very important, as it determines the factor by which the induced EMF V_H is multiplied. This quality factor, Q , equals $\omega_0 L / R$, where ω_0 is the angular resonant frequency of the tuned circuit. The ESR can be calculated with the help of the formulae quoted in Section 3, but is very difficult to measure with any ordinary component bridge. It is better to connect the antenna to a high-impedance measuring instrument and determine the 3 dB bandwidth. Q is then given by

$$Q = f_0 / (f_{-3\text{dB}2} - f_{-3\text{dB}1}), \quad \approx 2 (f_{-3\text{dB}2} + f_{-3\text{dB}1}) / (f_{-3\text{dB}2} - f_{-3\text{dB}1}),$$

where f_0 is the resonant frequency of the tuned circuit, and $f_{-3\text{dB}2}$ and $f_{-3\text{dB}1}$ are the two frequencies at which the response has fallen by 3 dB.¹⁹

¹⁸ 1Ω is a generous estimate of the ESR. What is more, the reactance of L is likely to be significant, so reducing the effect of the ESR even further.

¹⁹ An alternative is to measure the output across the inductor, with and without the resonating capacitor. The ratio of the two values gives Q .

Three antennas were made as illustrated below, and their Qs measured over the frequency range 2 MHz to 30 MHz:

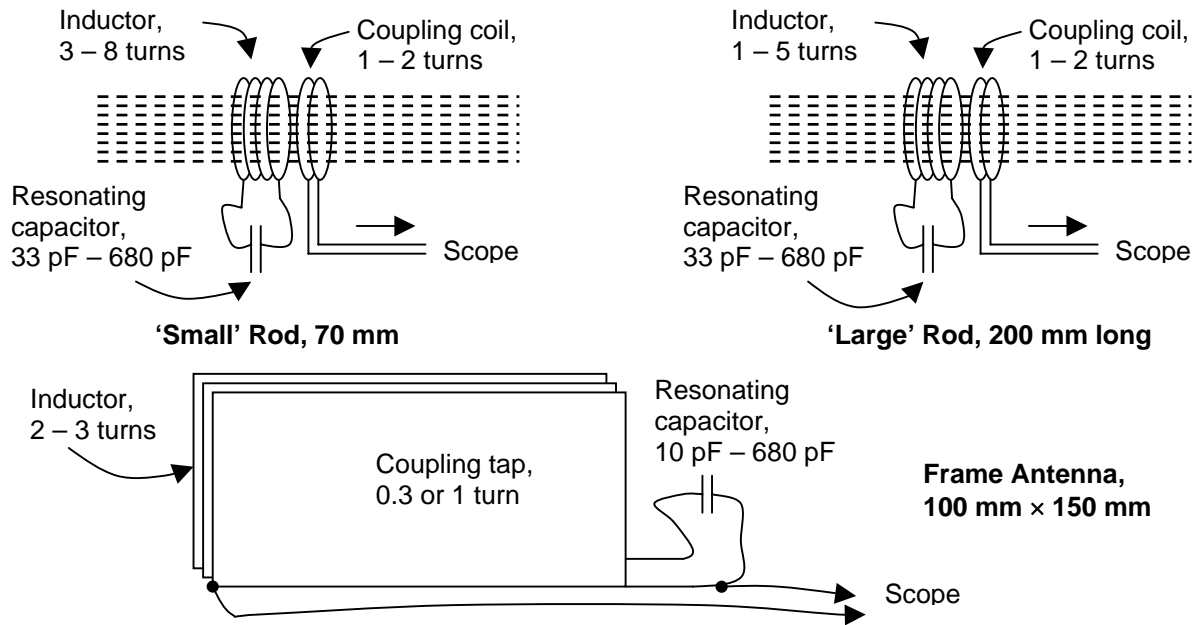
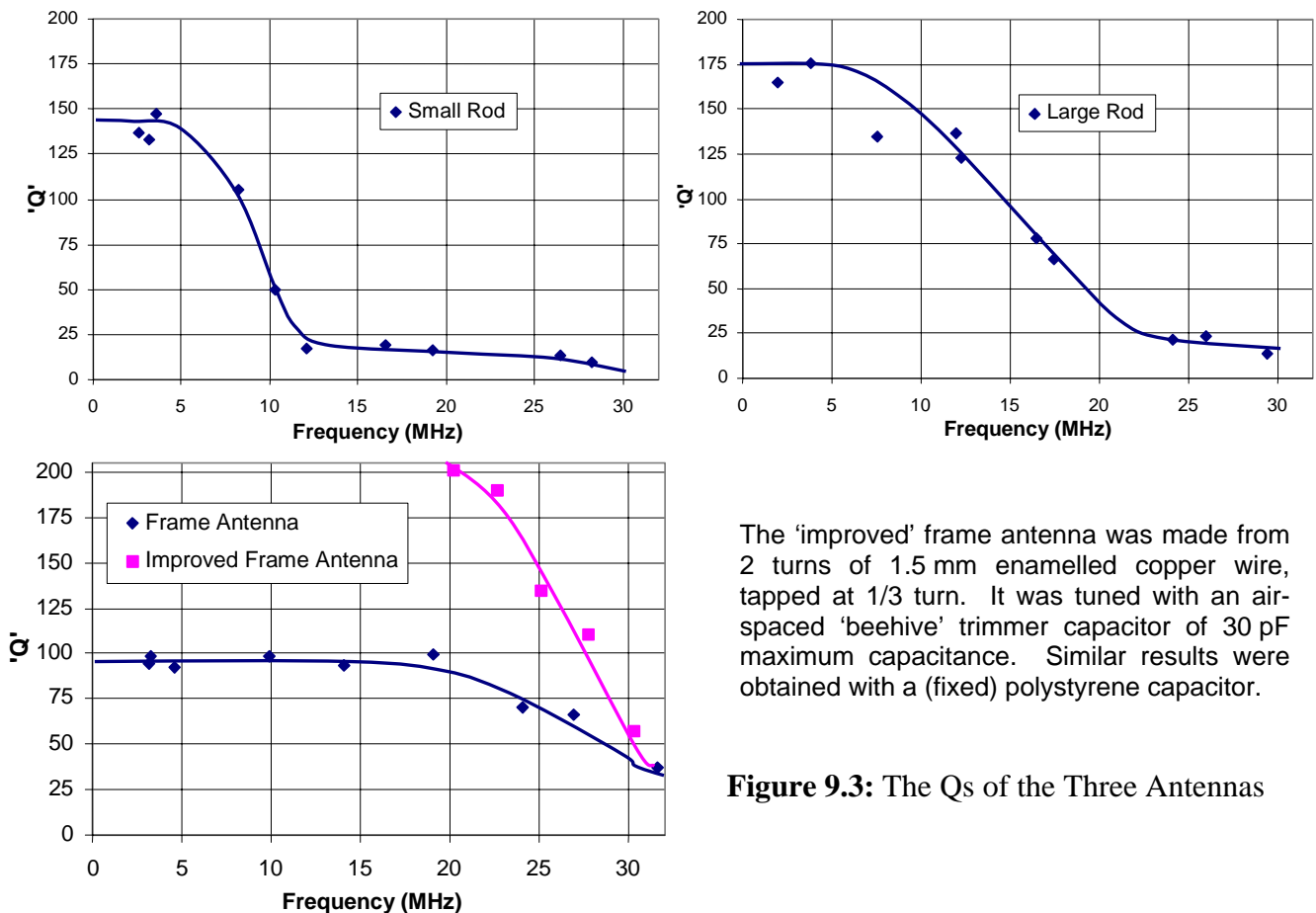

Figure 9.2: The Three Antennas Tested

Because of the wide frequency range, both the number of turns and the resonating capacitors had to be changed. The input impedance of the scope was low enough to damp the tuned circuit, even when buffered with a $\times 10$ probe; hence the need for a coupling coil. Full details of the various parameters are not quoted alongside the results below, as generally they did not make much difference. For instance, a particular resonant frequency could be maintained by doubling the number of turns and quartering the capacitor value. The measured Qs, before and after, would be nearly the same.



The 'improved' frame antenna was made from 2 turns of 1.5 mm enamelled copper wire, tapped at 1/3 turn. It was tuned with an air-spaced 'beehive' trimmer capacitor of 30 pF maximum capacitance. Similar results were obtained with a (fixed) polystyrene capacitor.

Figure 9.3: The Qs of the Three Antennas

All three antennas achieve respectable Qs at low frequencies. However, it is disappointing that their performance at higher frequencies bears little relationship to the predictions of Spreadsheet 'A'. In the case of the 'small' rod, the Q should equal the ratio of μ_r' to μ_r'' , where μ_r' and μ_r'' are as shown in Figure 5.1. In fact, the measured Q is rather better: at 4 MHz, it is still close to its maximum value of 140, whereas it should have fallen to about 20. What is more, there is a long 'tail' above 12 MHz, where the Q remains at around 20 instead of falling to unity. It is possible that the ferrite material was not Neosid F14 as supposed, or it could be that manufacturing tolerances were to blame.

The 'large' rod performs better at high frequencies, but the material is still too lossy for the antenna to be useful above 15 MHz.²⁰ As the material is unknown, Spreadsheet 'A' cannot provide figures for the predicted performance.

However, the true winner of the contest is the frame antenna. When the antenna was made of thin PVC-insulated flex, its Q was not spectacular at low frequencies, but held up well at high frequencies. The second, pink, plot shows the impressive improvement gained by using 1.5 mm enamelled copper wire instead. An air-spaced 'beehive' trimmer capacitor was substituted for the range of fixed polystyrene capacitors, but without significant effect on the performance. The rapidly decreasing Q above 23 MHz is something of a mystery. It cannot be explained either by radiation resistance, which should be negligible, or by skin effect, which has only slight frequency dependence.²¹ Possibly, losses occur as a result of interaction with the external environment: suspending the loop as far as practicable from other objects gave a further increase in Q.

In summary, the frame antenna has much to commend it. It is cheap and simple to make, and can provide a high Q. There is probably no way of maintaining the Q to the top edge of the band, as losses in the environment seem inevitable. A likely offender in that respect would be the structure of the receiver itself. Perhaps Spreadsheet 'A' could be developed to include a more realistic model for the high frequency losses.

10. Relative Effectiveness of the Antennas

When it comes to making a choice of antenna, the Q is not the only important factor. The output level depends directly on the flux linkage as well. Chart 10.1 overleaf provides a comparison of the levels to be expected from antennas of the types just discussed: 'small' rods, 'large' rods and frames. Of course, 'large' rods are of little more than academic interest, as they are hardly suitable for portable receivers.

Spreadsheet 'A' was used to calculate the levels as follows. The field strength was set to the 'standard' 10 mV/m, or rather the equivalent 26.5 μ A/m. The dimensions of the rod or frame were set to the required values, and the number of turns adjusted to give rise to an inductance of 6 μ H. It was assumed that μ_r' of the rod material was 125, and that the operating frequency was 10 MHz. Under these conditions, the spreadsheet gives reliable values for the untuned output levels. Unfortunately, as Section 8 shows, the ESRs or Qs are not accurately calculable. Hence the Q of each rod antenna has been taken as 150, and the Q of the frame antenna as 200 — values which experiment suggests are reasonable.

²⁰ It might seem strange that the rod was originally intended for use up to 30 MHz. However, in that application, the antenna coil was untuned, and the losses introduced by μ_r'' would not be significant.

²¹ The resistance associated with skin effect is proportional to the square root of frequency. Since the Q for a given resistance is proportional to frequency, the implication is that Q should increase as the square root of frequency.

	'Small' Rod	'Large' Rod	Frame
	9.5 mm diameter	25 mm diameter	100 mm breadth
Length (mm)	35	50	50
Turns	10.88	6.31	5.90
Level (dBm)	-39.0	-32.5	-25.1
Length (mm)	70	100	100
Turns	9.09	5.27	4.63
Level (dBm)	-33.1	-27.6	-21.2
Length (mm)	140	200	150
Turns	7.89	4.29	3.98
Level (dBm)	-27.7	-21.9	-19.0

Chart 10.1: Output Levels from the Different Antennas

Once again, the frame antenna is the winner: it would outperform the 'large' rod even if the Qs were taken to be the same. The trends apparent in the chart are interesting:

- The output level of a rod antenna is nearly proportional to the rod length.
- For a given rod length, increasing the radius of the rod antenna does not greatly increase the output level. This is because the number of turns has to be reduced to maintain the self-inductance.
- The output of the frame antenna increases gently as a function of its area. Doubling the area increases the signal level by approximately 3 dB.

11. Antenna Directivity

The practical design of the antenna depends on how important directivity is felt to be. An ideal H-field device exhibits a figure-of-eight pattern, with the sensitivity varying as the cosine of the angle made with the field. However, because the antenna is tuned, its circuitry possesses a very high impedance and is therefore susceptible to E-field pick up; that is, the loop doubles as a short whip antenna. The result is a distorted response:

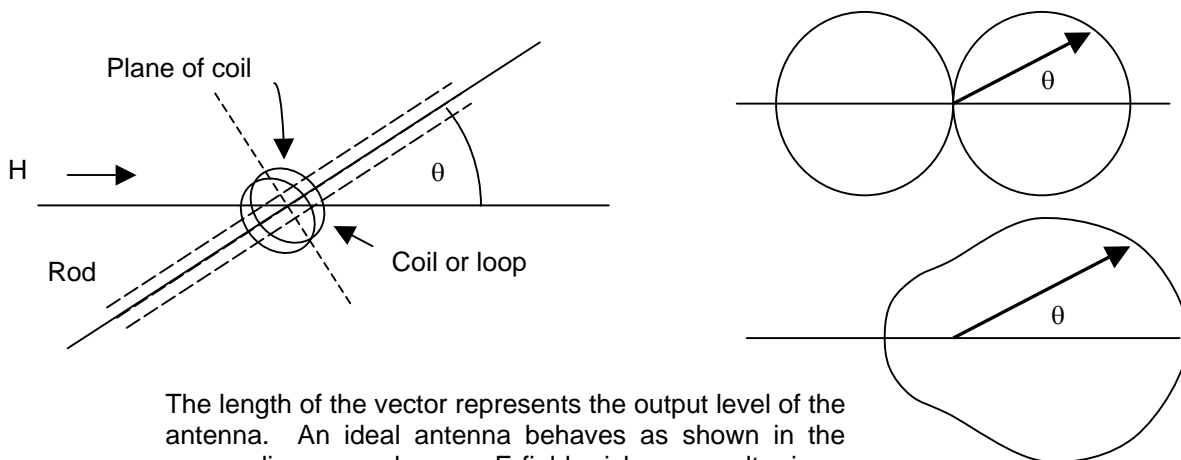

The length of the vector represents the output level of the antenna. An ideal antenna behaves as shown in the upper diagram, whereas E-field pick-up results in a distorted response such as that in the lower diagram.

Figure 11.1: E-Field Pick-up and Antenna Directivity

The exact shape of the polar response depends on both the ratio of the E-field to H-field pick-up and the relative phase. If the component due to the E-field is a problem, electrostatic screening of the coil is possible, although it is important to avoid creating a shorted turn. Also, the additional capacitance between the coil and earth could be a nuisance.

Another possibility is to neutralise the E-field pick-up by using a balanced circuit configuration:

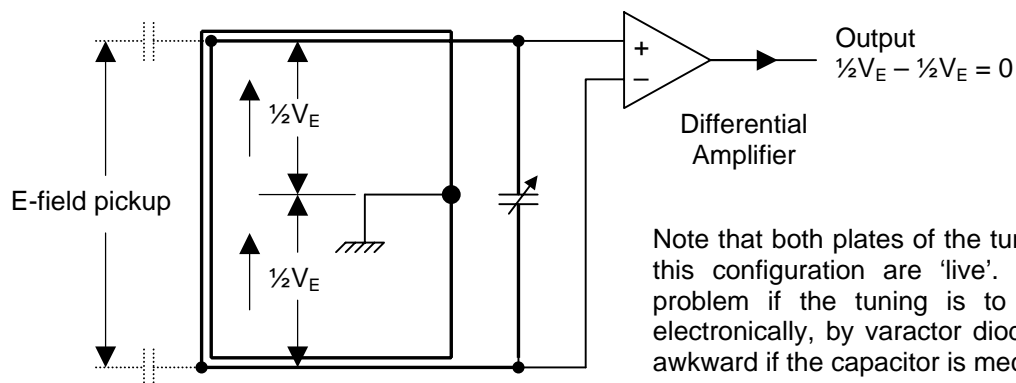

Figure 11.2: Cancellation of E-Field Pick-up

The author has also seen a ferrite rod antenna design where the output from a plate (E-field) antenna was deliberately coupled into the coil, with the aim of cancelling out the E-field pickup.

12. Conclusion

This report has looked at the design of loop and ferrite rod antennas, and has provided a model to assist with the discussion. The model successfully calculates both the self-inductance and the untuned output level of the antenna: predictions and measurements agree well. However, calculation of the *tuned* output level requires knowledge of the equivalent series resistance of the antenna coil, and it seems that this can only be determined by experiment. In the case of the loop antenna, skin effect and radiation resistance alone would result in greater Qs than actually measured. More work is required to explain the results.

If the choice is to be between a loop and a ferrite rod antenna at HF, the loop has much to commend it. The loop tested during the writing of this report was of modest size — 150 mm by 100 mm, and yet it outperformed an unrealistically large ferrite rod antenna. Such a loop also has the virtues of light weight and cheapness. A possible problem is that the loop would have some sensitivity to metalwork placed within it — a factor that would have to be considered in a practical design. Although the loop appears to be the better choice, a ferrite rod would certainly be usable where space is limited. If a rod is chosen, there seems little advantage in using one of large diameter: length is more important.

As H-field antennas are naturally of fairly low efficiency, thought must be given to the effects of spurious E-field pickup. The resultant distorted polar response may or may not be a problem. If E-field pickup is undesirable, it may be reduced either by electrostatic screening or by adopting a balanced circuit configuration.

Another interesting topic for investigation is the use of more than one antenna, either to provide diversity reception or to provide a particular polar response. The author hopes that work can continue!

13. Acknowledgements

The author would like to thank John Sykes and Jonathan Stott for commissioning this report. Both Jonathan and John Salter were helpful in providing references. John Sykes lent the large antenna rod, and Mark Waddell provided the ‘standard’ MF rod — which was intentionally destroyed during testing!

14. References

1. KRAUSS, J D. Antennas (second edition). McGraw-Hill International Editions, ISBN 0-07-100482-3.
2. BYTEMARK. Ferrite rods, bars, plates and tubes. CWS ByteMark.
<http://www.bytemark.com/products/rod1.htm>
3. AMIDON. Broadband transformers: ferrite rods, bars, plates and tubes. Amidon Associates Inc. http://www.amidon-inductive.com/aai_ferriterods.htm
4. NEOSID Material specifications — F14. <http://www.neosid.com.au/f14.html>
5. CROSS, R, 2001. Some magnetic field properties of ferrite rods used for some ferrite loaded receiving antennas solved by the moment method.
http://home.att.net/~ray.l.cross/murod_mm/
6. MEGURO. MLA-1001B test loop: user manual. Meguro Electronics Corporation.
7. B I BLEANEY and B BLEANEY, 1965. ‘Electricity and Magnetism.’ (Second Edition) Oxford at the Clarendon Press.
8. BRITISH STANDARDS PUBLISHING LIMITED, 1995. Methods of measuring and expressing the performance of radio receivers for sound broadcasting. BS 4054, Part 1.
9. ITU RADIOCOMMUNICATION ASSEMBLY, 2001. ‘Radio Noise.’ ITU-R P.372-7.

15. Tools

The Excel spreadsheet is available here:

<http://www.bbc.co.uk/rd/pubs/whp/whp-pdf-files/whp091excel.xls>

Appendix 1: The Spreadsheet Calculator

This spreadsheet was designed to allow easy comparison of different receiving antenna types, and in particular to determine whether ferrite rods are useful at HF. Both the self-inductance and the output voltage are calculated. A simulated test loop is included, so that the predicted results can be checked against laboratory measurements. Although the use of the spreadsheet should be fairly self-explanatory, some guidelines are given below. The internal calculations are also discussed.

A1.1 Generating the Field

The diagram below shows how details of the generating loop are presented. Parameters in blue are adjustable, whilst those in red are calculated.

Generating Loop Details								
Radius <i>or</i> (mm)	Length & (mm)	Breadth (mm)	Axial = 1 Planar = 2	Turns	Power (dBm)	Swamp R (Ω)	Distance (mm)	Field (uA/m)
125			1	1	10.0	86	1000	79.37
Effective radius		125 (mm)			0.010 (W)	1.414 (EMF)	10399 (uA)	29.92 (mV/m)

Figure A1.1: Generating Loop Characteristics

The loop can be either circular, in which case the radius is entered, or rectangular, when the length and breadth should be entered instead. If the loop is rectangular, the spreadsheet calculates the radius of the circular loop that would possess the same area. The field is calculated from the standard formula

$$H_z = (I b^2 / 2) / (b^2 + z^2)^{3/2},$$

where I is the current, b is the radius of the loop, and z is the axial distance from the loop.²² As the Meguro test-loop [6] is a standard means of generating the field, the figures shown above relate to this. However, they are easily changed. A series or ‘swamp’ resistor is included so that the self-inductance of the loop has a negligible effect on the loop current.²³

Two final points: Firstly, although the generating and receiving loops are normally coaxial, it is sometimes more convenient for them to be coplanar. In that case, the field strength is halved. The spreadsheet allows either configuration. Secondly, it is conventional to quote the equivalent electric field strength, E. The assumption is that E/H equals the impedance of free space, or approximately $120\pi \Omega$.

A1.2 Receiving the Field

Details of the coil used to receive the field, and hence generate an EMF, are entered as shown overleaf. Once again, the coil can be either circular (for ferrite rod antennas) or rectangular (for frame antennas). Although the geometry of the loop and the diameter of

²² For a derivation of this formula, see [7], for instance. For the case of a rectangular loop, the use of an ‘equivalent radius’ gives a very slight error.

²³ The strange value of 86Ω included with the Meguro loop gives an equivalent electric field of 10 mV per metre at a distance of 0.6 metres, when the generator source impedance and EMF are 50Ω and 1 V respectively. Ours not to reason why! The generator power quoted in the spreadsheet is that which would be dissipated in a 50Ω load; that is, it corresponds to the level displayed by the generator.

its wire do not directly affect the calculation of EMF, the same is not true for the self-inductance; hence the need to enter these figures.

Receiving Coil Dimensions		(for both ferrite rod and loop antennas)						
Circular	or	Rectangular		Ferrite ?	All			
Radius (mm)		Side 1 (mm)	Side 2 (mm)	(Y/N)	Length (mm)	Wire Diam. (mm)	Turns (n)	Area (sq mm)
5				y	8	0.8	8	79

Figure A1.2: Receiving Loop Characteristics

A1.3 Calculating the Effective Permeability of a Ferrite Rod

If a ferrite rod is being used, the length, diameter and complex relative permeability of the material should be entered. The spreadsheet then calculates two effective permeabilities: Mu_Coil (or μ_{coil}) refers to the amount by which the presence of the ferrite multiplies the natural self-inductance of the coil; Mu_Rod (or μ_{rod}) is the multiplier for the EMF generated by an external field.

Ferrite Rod Details					
Length (mm)	Diameter (mm)	Perm. Imag (ur)	Perm. Re (ur)	Mu_Coil (ucoil)	Mu_Rod (urod)
140	9.3	1.25	125		
Calculated figures from above				13.5	53.7

Figure A1.3: Ferrite Rod Characteristics

Both μ_{rod} and μ_{coil} are calculated from empirically derived formulas. μ_{rod} is relatively straightforward. The manufacturer's information [3] suggests a simple power law relationship between μ_{rod} and the ratio of length to diameter:

$$\mu_{rod} = (l/d)^{5/3} + 2.5, \text{ for } \mu_{rod} \ll \mu_r.$$

The constant of 2.5 is needed to give the correct value of μ_r when l/d is small. Note that the formula suggests that the permeability of the material has no effect. This cannot be true for large values of l/d , since μ_{rod} is limited by μ_r . The formula is therefore modified as follows:

$$\mu_{rod}' = (\mu_{rod} \times \mu_r) / (\mu_{rod} + \mu_r).$$

Agreement with the published figures is then good over a wide range of permeability.

Calculation of μ_{coil} is much more problematic, as it depends on both the geometry of the coil and of the rod — and not straightforwardly. Furthermore, only limited information is available from manufacturers, and some reliance has to be placed on the Ray Cross spreadsheet.²⁴ [5] A start is made by assuming that the coil itself is very short in relation to the length of the rod, and that μ_r is very large. If that is true, μ_{coil} is small and approximately proportional to l/d . The proportionality breaks down for larger values of l/d , and so there is a need to introduce a square term:

$$\mu_{coil} = (2 + l/d) \{ 1 - k (2 + l/d)^2 \},$$

where $k \approx 1/145$. This formula gives good results for $l/d = 40$ and below, but would obviously not be suitable for very large values of l/d .

²⁴ Some of the predictions from the Ray Cross spreadsheet were tested in the lab with the limited materials available — that is, two grades of ferrite — and found to be reasonably good. It was then assumed that the spreadsheet was accurate for other grades.

Where μ_r is finite, the expression needs to be modified so that μ_{coil} is lower when l/d is large. The easiest way of doing this is to replace the constant k with k' , such that

$$k' = k (1 + k'' / \mu_r) ,$$

where $k'' \approx 1/150$. This modification works reasonably well for all likely values of μ_r and l/d . However, the predicted value of μ_{coil} is too low when μ_r is small and l/d large.

The final correction carried out is to allow for the coil length being finite. It is fortunate that, for use at HF, the coil is generally short: firstly because the calculations are easier, and secondly because the ratio of μ_{rod} to μ_{coil} is maximum. However, the same is not true for ferrite rod antennas designed to work at lower frequencies, and the manufacturers tend to give figures that assume the coil and rod lengths are comparable. [3] Where that is the case, μ_{coil} is generally much greater than implied by the above calculations.

No particularly elegant method of calculating the correction factor could be found. However, if μ'_{coil} is the corrected value of μ_{coil} , and l_c is the length of the coil,

$$\mu'_{coil} \approx \mu_{coil} \{1 + (l_c/l) (l/d)^{3/4}\} .$$

This works well for values of l_c/l below 0.25. The correction factor falls to zero for short coils, and so its scope for doing harm is limited!

The 'raw' and corrected values of μ_{coil} are displayed, although only the fully corrected one is used to calculate the signal picked up from the coil:

Mu_Coil Calculator		
ur = inf	13.3	(zero coil length)
ur = actual	9.4	
ur = actual	13.5	(finite coil length)

Figure A1.4: Uncorrected and Corrected Values of μ_{coil}

A1.4 Calculating the Effective Self-Inductance of the Coil

There are several empirical formulas available for calculating the self-inductance of a coil, mostly due to Wheeler. Which one is best depends on the geometry of the coil. Where the radius r is greater than the sum of the length l and thickness t , the following is suitable:²⁵

$$L_{\mu H} = 2.92 r N^2 \log_{10} \{4.9 r / (l + c)\} .$$

All dimensions are in metres, and N is the number of turns. In the spreadsheet, c is taken as the diameter of the wire, and l is the value of l_c used previously.

Note: For rectangular loops, an equivalent radius is first calculated from the enclosed area. Alternatively, the 'Grover' formula gives good results provided that there is only a single turn — unfortunately, not normally the case when discussing frame antennas.

Self-inductance		
Radius (r mm)	Perm. (uc)	Inductance (uH)
5.00	13.5	5.59
"Grover" for single-turn rectangular loops		

Figure A1.5: Calculated Value of Self-Inductance

Finally, $L_{\mu H}$ is multiplied by μ_{coil} to give the actual self-inductance of the coil, L_{coil} .

²⁵ This formula is particularly suitable for frame antennas, where r is large, and usable for HF ferrite rod antennas, where l is small. Since writing the report, the spreadsheet has been modified to include a formula for solenoids, where l is appreciable. The spreadsheet automatically selects the more appropriate formula.

A1.5 Calculating the Untuned Output Level of the Coil

The H field has already been calculated, in Section A1.1, and in principle the EMF E_{HU} of the coil is easy to determine:

$$E_{HU} = N (\mu_{rod} \mu_0) H (\pi r^2) (2\pi f) ;$$

that is, the number of turns N , times the flux density $\mu_{rod} \mu_0 H$, times the area πr^2 , times the angular frequency $2\pi f$. μ_0 is the permeability of free space, or $4\pi \times 10^{-7}$, and μ_{rod} was calculated in Section A1.3.

Output Level into ?				Inf	50
E Field or (mV/m)	H Field (uA/m)	Perm. (urod)	Frequency (MHz)	Output (mV)	Output (mV)
		53.7	2	0.04	0.02
0.00	79.37			-74.5	-79.2
(Equivalent figures)				(dBm)	(dBm)

Figure A1.6: Calculated Untuned Output Level

This value of E_{HU} appears under ‘Inf’ in the spreadsheet. A value for the H field or equivalent E field may be entered locally in place of that calculated for the test loop.

Normally, E_{HU} is the important quantity when calculating the performance of an antenna. However, when checking the performance in practice, it may be necessary to use low-impedance test equipment, for example a spectrum analyser. The final column in Figure A1.5 shows the measured level for any stated impedance — 50Ω in this case. It is assumed that the output impedance of the loop $j X_L$ equals $j L_{coil} \times 2\pi f$. If so, the voltage appearing across a resistive load R is given by

$$V_{load} = E_U / \{ 1 + (2\pi f L_{coil})^2 \}^{-1/2} .$$

A1.6 Calculating the Tuned Output Level of the Coil

In most practical applications, the ferrite rod antenna is tuned by placing a capacitor across it. Doing so increases the output voltage by a factor equal to the quality factor Q of the tuned circuit. The penalty is that the antenna must now drive a high impedance.²⁶

The user of the spreadsheet may either enter Q directly, or enter an equivalent series resistance (ESR) instead. Q then equals $2\pi f L_{coil} / ESR$. Unfortunately, there is no fully satisfactory way of determining ESR.²⁷ The ‘safe’ way would be to make a practical measurement, although doing so somewhat spoils the theoretical purity of the spreadsheet.

Tuned Output Level			
Capacitor (pF)	ESR or (Ω)	Q Factor	Output (mV)
1132.1		200	4.2
	0.35	100	-34.5
			(dBm)

Figure A1.7: Calculated Tuned Output Level

²⁶ Where the tuned antenna has to drive a low impedance, a coupling coil with a small number of turns is needed. Of course, the available signal voltage is then less.

²⁷ The latest version of the spreadsheet includes formulae for the losses associated with skin effect and radiation resistance. Unfortunately, agreement with practice is not good. The output level is quoted, perhaps misleadingly, in dBm as well as millivolts. This figure equals the power that would be present if the output voltage appeared across a 50Ω resistor. Of course, the actual power is zero.

When the ferrite rod is present, most of the losses are associated with the imaginary component of the relative permeability. The ratio of the real to imaginary components corresponds to Q, and this is the figure that should be entered into the spreadsheet. Q is about 150 for F14 material at frequencies below 2 MHz.²⁸ [4]

Also given is a value for the capacitor needed to resonate the antenna. Practical considerations usually limit the range to between about 15 pF and 500 pF.

A1.7 Calculating the Output from an E-Field Antenna

It was hoped to include a calculator for the output of an E-field antenna, or ‘whip’. In principle, the calculations are easy to make, as explained earlier in this report. If the antenna is taken to be a capacitor of plate separation d and the field strength is E, the EMF E_U is given by

$$E_{EU} = E/d .$$

The output of a whip antenna of length d is half this, as the antenna responds to the average potential along its length.

Receiving Whip Antenna	
Length (mm)	Output (mV)
500	7.48

Figure A1.8: Calculated EMF from a Whip Antenna

Unfortunately, the calculation is of only limited use. The EMF of a whip is rarely usable directly, as the impedance is inconveniently high. Also, the efficiency of the associated ground plane and the geometry of the system are important factors. Designing a more complete calculator is left as an exercise for the reader!²⁹

²⁸ There is a slight approximation here. The assumption is that μ_r is much greater than 1. A second assumption is that the manufacturer’s figures are correct: measurement of the very small imaginary component in the presence of the large real component is presumably quite difficult.

²⁹ It is worth mentioning that the Meguro loop is no use for testing E-field antennas, even though its output is quoted in terms of the equivalent E field.