

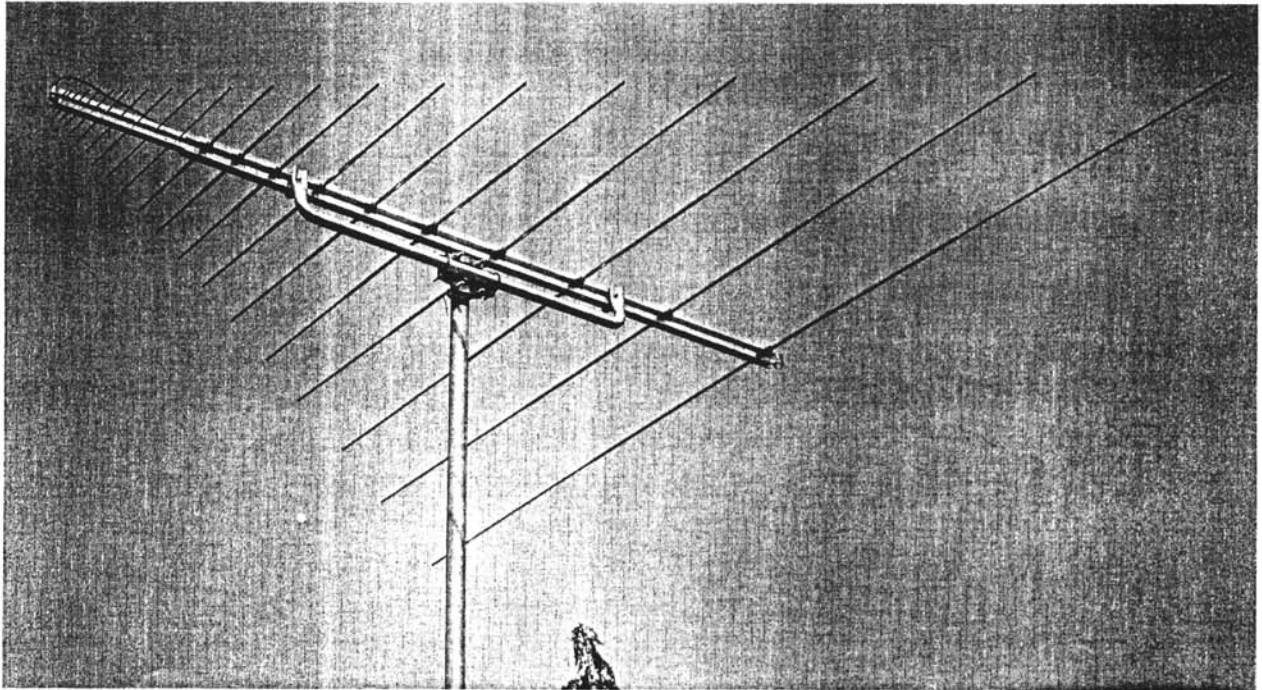

# Log Periodic Antenna

# CLP5130-x CLP3100

- ★ Wide Band
- ★ Low VSWR
- ★ High Gain
- ★ Small Size
- ★ Light Weight
- ★ Easy Assembly



CD MODEL CLP5130-1 is a high gain, wide band VHF and UHF log periodic type beam antenna. As a standard, the antenna is designed for horizontally polarized base station use but by means of an adapter, vertical polarization is also possible. The antenna is usable in the amateur bands from 50 thru 1300 MHz and is also suitable for FM broadcasting, scanning, VHF/UHF television air band communications, government applications, and business band use.

Forward gain of the CLP5130-1 from 50 to 1300 MHz is 10 to 12 dBi (this is 10 to 16 times the gain compared to a nondirectional discone type antenna). The VSWR of the antenna is less than 2.0:1 across the band. Mechanically, the log periodic uses a specially shaped high quality aluminum boom that allows for movement of the phasing line. In addition, distortions in the vertical and horizontal planes have been minimized, and adjustment of the element alignment is not necessary. The assembly of the antenna is easy. The boom to mast bracket is made of a lightweight and rugged magnesium alloy.

Model CLP5130-2 is very compact and high performance log periodic antenna which covers from 105 thru 1300 MHz while model CLP5130-3 covers from 90 thru 220 MHz.

## SPECIFICATIONS

Model No.	CLP5130-1	CLP5130-2	CLP5130-3	CLP5130-1X	CLP3100
Frequency	50~1300MHz	105~1300MHz	90~220MHz	50~500MHz	30~1000MHz
Number of Element	21	17	12	18	27
Polarization	H or V	H or V	Horizontal	H and V	H or V
Forward Gain	10~12dBi	11~13 dBi	12~ 13 dBi	10~12dBi	10~12dBi
F/B Ratio	10~15 dB	10~15 dB	10~15 dB	10~15 dB	10~15 dB
Impedance	50 Ohms	50 Ohms	75 Ohms	50 Ohms	50 Ohms
VSWR	2.0:1 or less	2.0:1 or less	2.0:1 or less	2.0:1 or less	2.0:1 or less
Power Rating	500W PEP	500W PEP	500W PEP	500W PEP	500W PEP
Boom Length	2.0m	1.4m	1.7m	1.9m	4.7m
Element Length	3m	1.3m	1.6m	3m	5.3m
Mast Size	48~61mm	42~50mm	42~50mm	48~61mm	48~61mm
Wind Survival Rating	40m/sec	40m/sec	40m/sec	40m/sec	40m/sec
System Net Wight	5kg	3kg	3.5kg	5kg	15.5kg
Recommended Rotator	RC5-1, 3	RC5-1, 3	RC5-1, 3	RC5-1, 3	RC5-1, 3

(Specifications subject to change without notice or obligation).

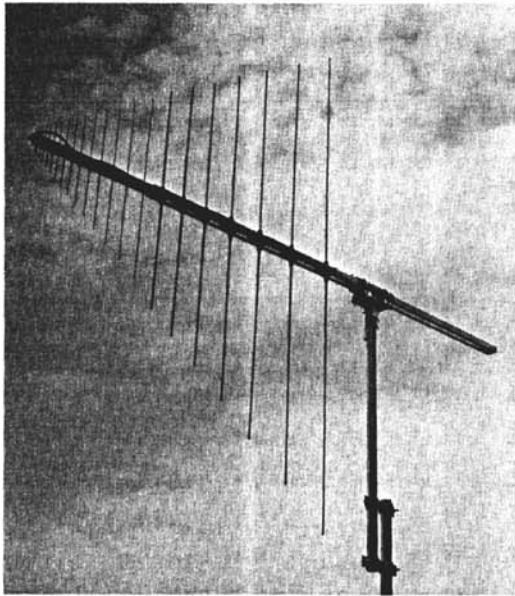

CLP5130-1M 50~1300MHz

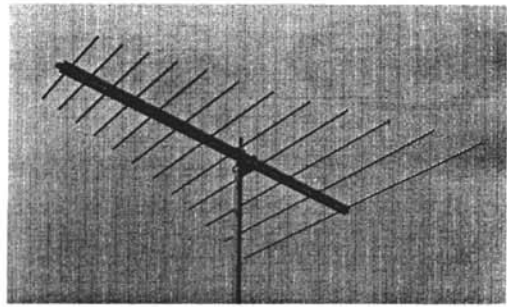

CLP5130-3 90~220MHz

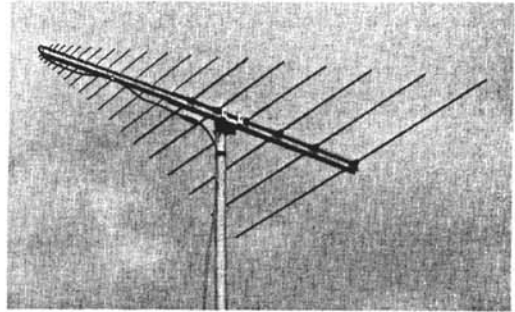

CLP5130-2 105~1300MHz

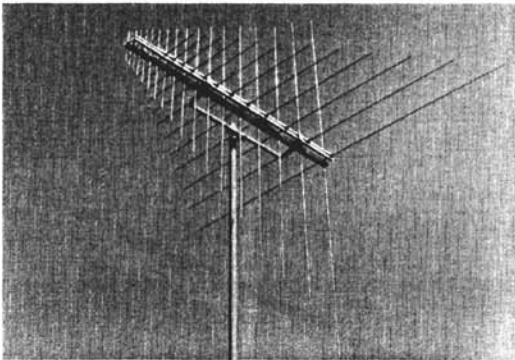

CLP5130-1x 50~500MHz

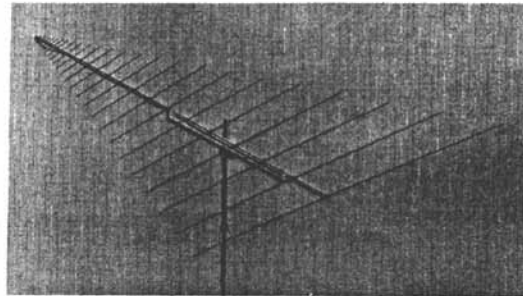

CLP3100 30~1000MHz

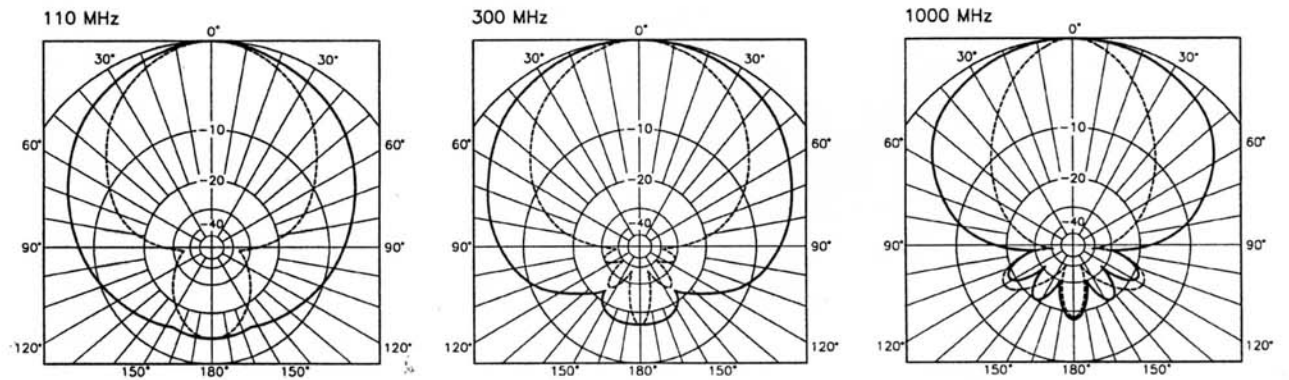

Model 5130-2, Azimuth Radiation Patterns.

----- HORIZONTAL POARIZATION  
 ————— VERTICAL POLARIZATION

